

STEREO SCENE: FACTORY ADJUSTMENTS & MALADJUSTMENTS

Popular Electronics

FIFTY CENTS / SEPTEMBER 1971

Selective TV Preamp Brings In Blacked-out Sports

ARE MODERN MILITARY
RADARS INFALLIBLE?

HOW THE COAST GUARD
FEELS ABOUT CB

TESTING POWER SUPPLIES

BUILD A SOLID-STATE
WARBLING BIRD

PRODUCT TESTS:
MAGNECORD 2001 TAPE DECK
HEATHKIT HM-102
RF WATTMETER
& OTHERS

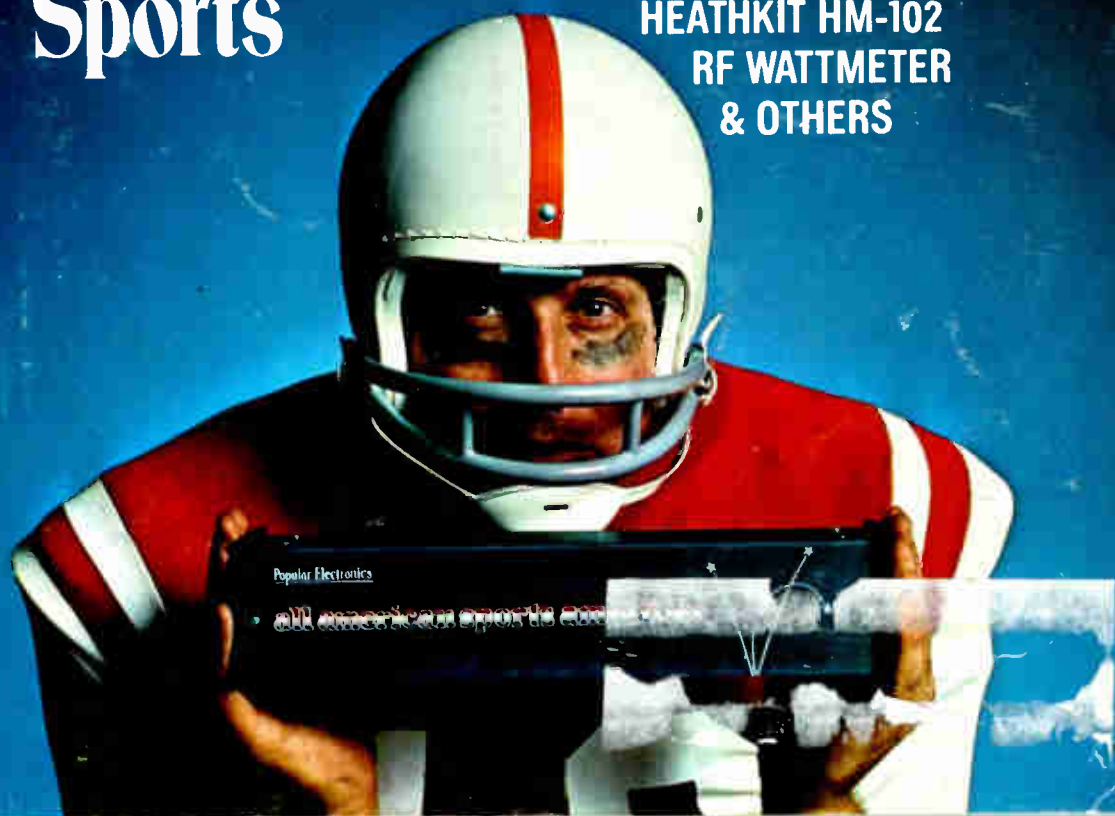

Discover the ease and excitement of learning Electronics with programmed equipment NRI sends you

When you train at home with NRI, you train with your hands as well as your head. You learn the WHY of Electronics, Communications, TV-Radio the NRI pioneering "3-Dimensional" way. NRI training is the result of more than half a century of simplifying, organizing, dramatizing subject matter, and providing personal services unique for a home study school. You get the kind of technical training that gives you priceless confidence as you gain experience equal to many, many months of training on the job.

NRI—The 53 Year Leader in Electronics Training



APPROVED UNDER NEW GI BILL

If you served since January 31, 1955, or are in service, check GI line in postage-free card.

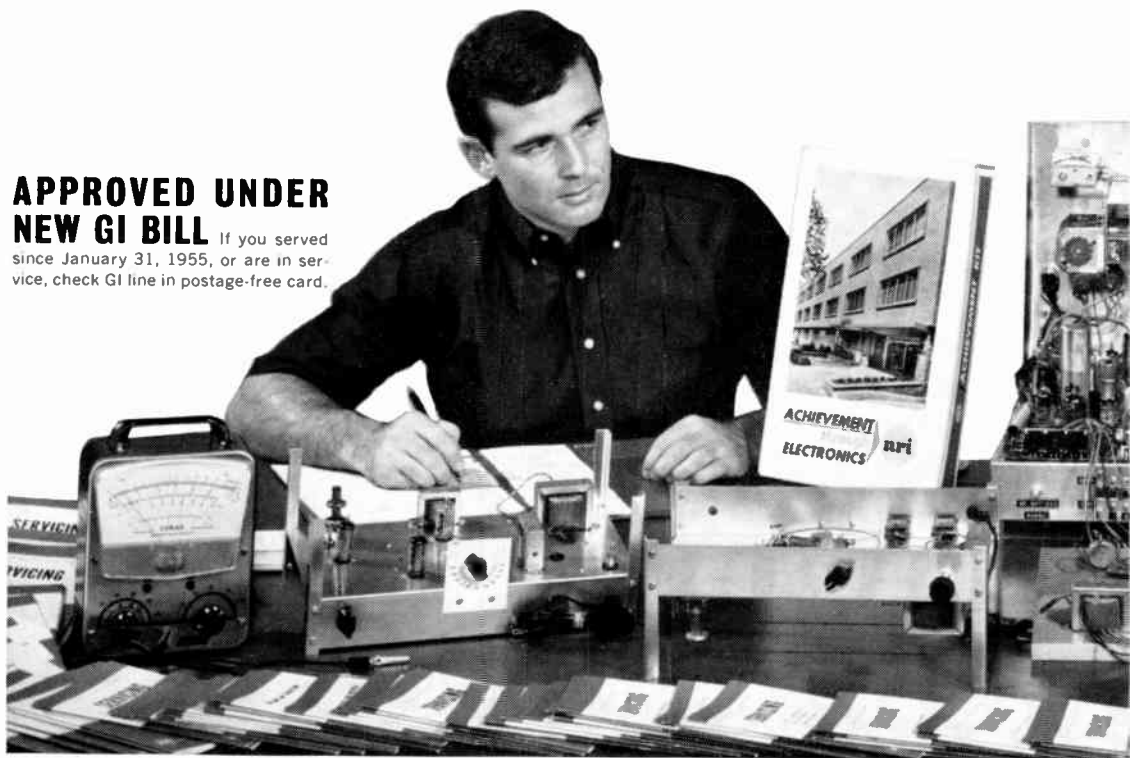

NRI's "discovery" method is the result of over half a century of leadership simplifying and dramatizing training at home

The FIRSTS described below are typical of NRI's half century of leadership in Electronics home training. When you enroll as an NRI student, you can be sure of gaining the in-demand technical knowledge and the priceless confidence of "hands-on" experience sought by employers in Communications, Television-Radio Servicing and Industrial and Military Electronics. Everything about NRI training is designed for your education . . . from the much-copied, educator-acclaimed Achievement Kit sent the day you enroll, to "bite-size" well-illustrated, easy to read texts programmed with designed-for-learning training equipment.

YOU GET YOUR FCC LICENSE OR YOUR MONEY BACK

There is no end of opportunity for the trained man in Electronics. You can earn \$6 or more an hour in spare time, have a business of your own or qualify quickly for career positions in business, industry, government. And if you enroll for any of five NRI courses in Communications, NRI prepares you for your FCC License exams. *You must pass* or NRI refunds your tuition in full. No school offers a more liberal money-back agreement. The full story about NRI leadership in Electronics training is in the new NRI Catalog. Mail postage-free card today. No salesman is going to call.
NATIONAL RADIO INSTITUTE, Washington, D.C. 20016

APPROVED UNDER NEW GI BILL If you have served since January 31, 1955, or are in service, check GI line on postage-free card.

designed from chassis up for your education

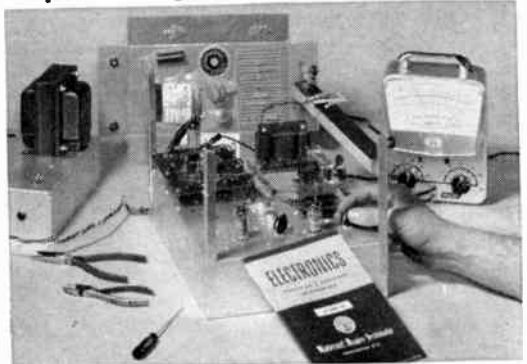
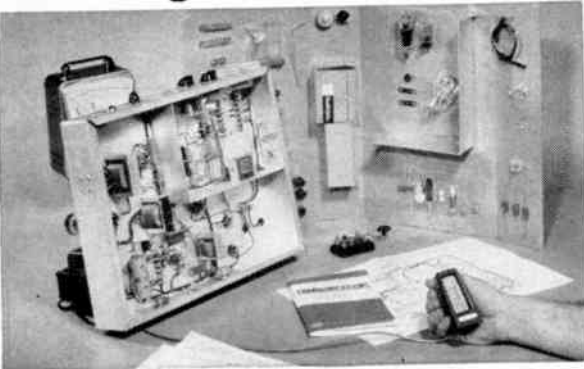

first to give you true-to-life experiences as a communications technician. Every fascinating step you take in NRI Communications training, including circuit analysis of your own 25-watt, phone/cw transmitter, is engineered to help you prove theory and later apply it on the job. Studio equipment operation and troubleshooting become a matter of easily remembered logic.

first to give you completely specialized training kits engineered for business, industrial and military Electronics. Shown above is your own training center in solid state motor control and analog computer servo-mechanisms. Telemetry circuits, solid-state multi-vibrators, and problem-solving digital computer circuits are also included in your course.

Popular Electronics

WORLD'S LARGEST-SELLING ELECTRONICS MAGAZINE

FEATURE ARTICLES

- | | | |
|---|-----------|-----------------------|
| ALL AMERICAN SPORTS AMPLIFIER
<i>Brings in TV channels outside the blackout</i> | 29 | Robert E. Cooper |
| CB AND THE COAST GUARD
<i>Why they can't cooperate</i> | 42 | Richard Humphrey |
| ARE MODERN MILITARY RADARS INFALLIBLE?
<i>Cross sections provide new info</i> | 45 | A. E. Judd |
| UNDERSTAND THE SYSTEM
<i>You don't have to know the circuits</i> | 52 | Walter H. Buchsbaum |
| THE SOLID-STATE BIRD
<i>Sings like a canary</i> | 58 | John S. Simonton, Jr. |
| THE OPERATIONAL AMPLIFIER
<i>Circuits and uses</i> | 61 | Ralph Tenny |
| TESTING POWER SUPPLIES
<i>Simple, accurate circuit</i> | 67 | James N. Demas |
| COMMUNICATIONS | 69 | Leslie Solomon |
| OPPORTUNITY AWARENESS | 76 | David L. Heiserman |
| THE PRODUCT GALLERY
<i>Magnecord 2001 Tape Deck</i>
<i>Heathkit HM-102 RF Wattmeter</i>
<i>Ramko Collimeters</i>
<i>Calgon Heat Sink Paste</i> | 78 | |
| STEREO SCENE
<i>All about adjustments</i> | 84 | J. Gordon Holt |
| SOLID STATE
<i>The versatile PFI</i> | 87 | Lou Garner |

DEPARTMENTS

- | | | |
|-----------------------------|-------------------|-------------------|
| DIRECT & CURRENT | 7 | Milton S. Snitzer |
| INTERFACE | 8 | |
| NEW LITERATURE | 12 | |
| ELECTRONICS LIBRARY | 14 | |
| NEW PRODUCTS | 22 | |
| READER SERVICE CARD | Back Cover | |

POPULAR ELECTRONICS is Indexed
in the Reader's Guide
to Periodical Literature

Copyright © 1971 by ZIFF-DAVIS PUBLISHING COMPANY. All rights reserved.

William Ziff, President; Hershel B. Sarbin, Senior Vice President and Secretary; Philip Sine, Financial Vice President and Treasurer
POPULAR ELECTRONICS, September 1971, Volume 35, Number 3. Published monthly at One Park Ave., New York, N.Y. 10016.
One year subscription rate for U.S., U.S. Possessions and Canada, \$6.00; all other countries, \$7.00. Second class postage paid
at New York, N.Y. and at additional mailing offices. Authorized as second class mail by the Post Office Department, Ottawa,
Canada and for payment of postage in cash. Subscription service and Forms 3579; P.O. Box 1096, Flushing, N.Y. 11352.
Editorial offices for manuscript contributions, reader inquiries, etc.: One Park Ave., New York, N.Y. 10016.

This month's cover photo by
Justin Kerr

AMPEX GETS INTO YOUR SYSTEM

Listen to one of these new Ampex tape decks and it's bound to get into your system. It's like experiencing sound in a pro studio. Pure sound. Smooth. Powerful. Funky. All the highs and lows. As close to audio perfection as possible. And like our professional models, these machines have everything you need, and nothing you don't. Made to complement the most sophisticated sound system. Yours.

Like the AX-300, an innovation-packed reel-to-reel stereo deck. 6 heads. 3 motors. Bi-direction record/play. Motion sensing. 4-source mixing "Function programmer." Stereo echo. Pause/edit. Logic circuitry. Auto reverse. 55 second fast wind time. Or the AX-50. This reel-to-reel stereo deck has 3 heads Direct tape monitor. Stereo echo Noise filter. Pause/edit. Auto shutoff.



AX-50

Auto tape lifters. Sound-on-sound. Sound-with-sound. Micro 335. The most advanced cassette deck in the industry. Can play/record 12 cassettes in any order. Has Ampex's new patented

bi-directional head for play/record in both directions. You never have to turn a cassette over. Pause control. Fast wind. Automatic shutoff. Two V.U. meters. Record level controls. Two motors.

AX-300



Our Micro 155 also contains our patented bi-directional head. Features solenoid assisted controls. Four-source mixing for reel-to-reel versatility. Chromium dioxide tape selector switch. Automatic reverse. Hysteresis synchronous motor. Pause control. Noise reduction switch. Ampex/Starr slot-loaded system. The Dynamic Duo. The Micro 54 and the HCR8. The 54 is a stereo cassette deck. slot loading. Auto eject. Pause control. hysteresis synchronous mo-

tor. Noise filter. The works. Its look-alike, the HCR8, is a stereo 8-track MICRO 54



HCR8

deck with automatic track advance. Track indicator lights. Power assisted eject. And much more. As you can see, they're a perfect match. Ideal for the audiophile who wants both cassette and 8-track capabilities. You've knocked yourself out building a beautiful sound system. So it's only right that you get the best when you're ready for a tape deck. And the best tape decks are Ampex. Period. Ampex. Get it into your system.



MICRO 155

AMPEX



THE SOUND IDEA PEOPLE

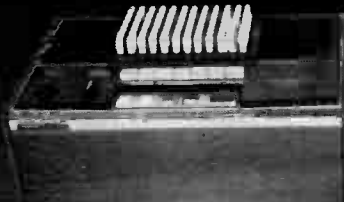

MICRO 335

IDENTICAL TWINNS



Professional or CB...we use identical components. You get identical performance.

Police communicators demand the things you want in a mobile antenna. Maximum range. Reliability. Long life. That's why A/S mobile CB antennas are built exactly like their professional counterparts—used by 9 out of 10 police vehicles. Put John Law's experience to work in your mobile.

M-176 Quick Grip[®]
CB antenna. Only

\$21.95
(suggested resale).



Be an "antenna specialist!" These top quality jackets with safety reflector stripes available only from your A/S dealer—just \$8.95.

**the antenna
specialists co.**



"Stripes of Quality"

Div. of **allen** Electric & Equipment Co.
12435 Euclid Ave., Cleveland, Ohio 44106
EXPORT: 220 Shames Dr., Westbury, L.I., New York 11690
CANADA: A. C. Simmonds & Sons, Ltd.

CIRCLE NO. 7 ON READER SERVICE CARD

Popular Electronics

LAWRENCE SPORN
Publisher

MILTON S. SNITZER
Editor

LESLIE SOLOMON
Technical Editor

JOHN R. RIGGS
Managing Editor

EDWARD I. BUXBAUM
Art Director

ALEXANDER W. BURAWA
Associate Editor

ANDRE DUZANT
Technical Illustrator

PATTI MORGAN
Assistant Editor

JUDITH L. HOGAN
Editorial Assistant

J. GORDON HOLT
L. E. GARNER, JR.
DAVID L. HEISERMAN
Contributing Editors

STANLEY NEUFELD
Associate Publisher

RICHARD J. HALPERN
Advertising Manager

MARGARET DANIELLO
Advertising Service Manager

FURMAN H. HEBB
Group Vice President
Electronics and Photographic

ZIFF-DAVIS PUBLISHING COMPANY
Editorial and Executive Offices
One Park Avenue, New York, New York 10016
212 679-7200

Midwestern Office
The Pottis Group, 4761 West Touhy Ave.,
Lincolnwood, Illinois 60644, 312 679-1100
GERALD E. WOLFE, DICK POWELL

Western Office
9025 Wilshire Boulevard, Beverly Hills, California 90211
213 CResview 4-0265; BRodshow 2-1161
Western Advertising Manager, BUD DEAN

Japan: James Yogi
Oji Polce Aoyomo; 6-25, Minami Aoyomo
6-Chome, Minoto-Ku, Tokyo 407-1930/6821

Circulation Office
P.O. Box 1096, Flushing, N.Y. 11352

William Ziff, President
W. Bradford Briggs, Executive Vice President
Hershel B. Sorbin, Senior Vice President and Secretary
Stanley R. Greenfield, Senior Vice President
Philip Sine, Financial Vice President and Treasurer
Walter S. Mills, Jr., Vice President, Circulation
Phillip T. Heffernan, Vice President, Marketing
Frank Pomerantz, Vice President, Creative Services
Arthur W. Butzow, Vice President, Production
Edward D. Muhlfeld, Vice President, Aviation Division
Irwin Robinson, Vice President, Travel Division
George Morrissey, Vice President
Sydney H. Rogers, Vice President

Ziff-Davis also publishes Airline Management, Boating, Business & Commercial Aviation, Car and Driver, Cycle, Electronics World, Flying, Modern Bride, Popular Photography, Skiing, Skiing Area News, Skiing Trade News, Stereo Review, and Travel Weekly.

Forms 3579 and all subscription correspondence should be addressed to POPULAR ELECTRONICS, Circulation Department, P.O. Box 1096, Flushing, N.Y. 11352. Please allow at least eight weeks for change of address. Include your old address, as well as new—enclosing if possible an address label from a recent issue.

EDITORIAL CONTRIBUTIONS must be accompanied by return postage and will be handled with reasonable care; however, publisher assumes no responsibility for return or safety of art work, photographs or manuscripts.



Member Audit Bureau
of Circulations

POPULAR ELECTRONICS



By Milton S. Snitzer, Editor

THE ELECTRONIC PARTS DISTRIBUTOR

Recently our Technical Editor, Les Solomon, and Associate Editor, Al Burawa, spent a couple of days in the Florida sunshine taking the pulse of the electronic parts distributor business. They reported that the distributor is very much alive and well, though he is changing his way of life. The occasion was the annual National Electronics Week trade show near Miami. Present were manufacturers, distributors, and reps handling products sold to electronics hobbyists and technicians through their local and not-so-local distributors.

True it's getting harder to buy individual components for projects; and that's why so many of our construction projects indicate sources of kits of parts. However, the blister-pack business is booming with more and more diodes, transistors, IC's, resistors, capacitors, connectors, and hardware available to the experimenter and hobbyist. And non-blister-pack items are far from extinct. Some distributors have switched to a minimum-price order policy and some have made an all-out effort to expand inventories to handle the most-used parts and items. Semiconductor manufacturers are also expanding their lines of general-purpose replacement devices.

There was quite a bit of test equipment on display at the Show. You are going to pay more for test equipment in the future, but you are going to get more versatile and better instruments for your money. Every major test equipment manufacturer is forging ahead with state-of-the-art instruments and circuits. Digital voltmeters, solid-state triggered-sweep scopes, vectorscopes, and miniature battery-powered color-bar generators were demonstrated. Portable meters with new plastic cases that would survive a drop from the bench top to the floor were shown and new tools for the experimenter were in abundance. As far as test equipment is concerned, the feeling at the NEW Show was definitely one of dynamic growth and confidence in the future. There were many imports, of course, along with the American-made gear.

The giants in the field are showing plenty of activity and change too. For example, Allied Radio Shack has reported the opening of its 1000th store, with present plans calling for a total of 1500 stores by 1973. The company now operates in every state except Hawaii, and has stores in Canada. Lafayette Radio Electronics recently announced the opening of its 46th fully owned store in major metropolitan areas from New York to Chicago. The company also has over 260 franchise stores operating all the way to the West Coast, with some 20 to 30 of these associated stores scheduled to open each year.

So, all in all, there are more products, more kits, more variety, and more places to buy them all—for the electronics hobbyist.

Discover the power
of your own voice!

Take our free voice analysis

Find out if you can be trained
as a newscaster, sportscaster,
disc jockey or announcer.

Now, find out—FREE—if you have a voice that can be trained for broadcasting. Just mail in the coupon for information about our free voice test. It was created with the help of John Cameron Swayze, Curt Gowdy, Fran Allison, and other members of the faculty of Career Academy's Division of Famous Broadcasters.

If you qualify for training, you can study at one of the Academy's many studios, or at home, in your spare time. Either way, your Career Academy Certificate prepares you for a Federal Communications Commission Third Class Operator's License with Broadcast Endorsement—in as little as a few months.

MAIL COUPON NOW...

for details on your
free voice analysis,
plus a free record
and colorful booklet.
There's absolutely
no obligation.



CAREER ACADEMY'S

DIVISION OF FAMOUS BROADCASTERS

International Headquarters School
611 E. Wells Street, Dept. N087-229
Milwaukee, Wisconsin 53201

I want to know if I have broadcasting talent worth developing. Please rush me more information. I am interested in:

Home Study Studio Training

Name _____
(please print)

Address _____

City _____

State/Province _____ Zip _____

Phone _____ Age _____
(Home, Business, or Neighbor)

Year of high school graduation _____

Check here if eligible for Veteran's Benefits
Accredited by the NATTS and NHSC.

CIRCLE NO. 9 ON READER SERVICE CARD



INTERFACE

HS STUDENTS AND ELECTRO-CULTURE

I would like to compliment you on your excellent article "More Experiments In Electro-Culture" (June 1971). It has given the advanced biology students in our high school



something to explore in the way of a special research project. Mrs. Bunch, the biology department head, is coaching the students, and I am helping the students build the necessary plant response detectors outlined in the article.

John Carl Mulroy
Memphis, Tenn.

EL PANEL FEEDBACK

The "EL Panel Driver" story (May 1971) was a very interesting article. A few months ago, I found a good use for an electroluminescent panel. I connected an EL panel to the output of a 15-watt audio amplifier, stepping up the voltage with a 6-volt filament transformer to the 8-ohm tap and using the primary side to obtain high-voltage audio to drive the EL panel. What I have now is an electroluminescent light organ that changes in intensity but not color.

Don Huber
Huntington, N. Y.

It was with great interest that I read Norman Huffnagle's article on EL panel electronics. I have been experimenting with electroluminescent panels since they first ap-

CIRCLE NO. 8 ON READER SERVICE CARD—>

new



COBRA 130

Full 15-watt peak envelope power input.*

SIDEPower! ® T.M.

69 modes to send and receive (equal to 69 channels)! You can always find a clear channel to transmit on. Separate receiver R.F. gain control (gives you absolute control over input signal on SSB operation)!

You've never seen anything like this new Cobra Single Sideband/AM Two-way CB Radio. Really reaches out and penetrates. With a full 15 watts peak envelope power input. And 69 separate communications channels (full range of 23 CB channels *plus* 46 SSB channels). And, frequency synthesizing so you don't need extra crystals. And, integrated circuitry for optimum reliability. And, full power, 12 V DC designed in a mobile unit. In a word, it's sensational!

- Maximum peak output power without overloading.
- Small! (2.55" x 9.0" x 11.38").
- Minimal power drain.
- Average battery current required is far less than with AM because carrier and one side band is suppressed on SSB.
- Series gate noise blanker system.
- Crystal lattice-type filter in sideband generation system.
- Solid state devices include F.E.T.'s and integrated circuit.
- Dynamic microphone and coil cord plugs right in.



Cobra

A Product of DYNASCAN CORPORATION
1801 W. Belle Plaine Chicago, Illinois 60613

THE SINGLE SIDEBAND UNIT OF THE FUTURE!



COBRA 130: \$349.95

*Maximum power permitted by the F.C.C.

INTERFACE

peared on the market. Lately, however, the EL panels have become hard to find. Sources that had them before no longer stock EL panels. Where can I get them now?

David L. Hoats
Bordentown, N. J.

Between the time of writing the article on EL panels and publication, we learned that both General Electric and Sylvania gave up the EL business. A company called Grimes Mfg., Urbana, OH 43078, has taken up the GE side of the EL panel area. We also understand that Edmund Scientific Co., 101 E. Gloucester Pike, Barrington, N. J. 08007 is considering carrying the panels (contact Mr. Herbert Karr for further details).

R/C RECORD PLAYER WANTED

With all the elaborate and overdone consumer items on the market, I am puzzled by the fact that no one has come up with a wireless remote-controlled record player. With such a setup, the user need only press a button on a small control box and his player

would repeat the same record or reject it and go on to the next disc in the stack.

Ken Greenberg
Chicago, Ill.

Your idea seems good on the surface, but you have failed to take into account the incredible complexity of today's sophisticated record players. Remote control of a purely electronic system is fairly simple; in a record player you are dealing with an essentially mechanical system and remote control is not so easy. Adding R/C to a modern player would entail too much in the way of redesign and expense to be practical. An R/C equipped record player would be very high priced — even by today's high-cost standards.

TRANSFORMER MODULATES LASER BEAM

The "Laser Beam Communicator" (May 1970) can be simplified by substituting a modulation transformer for the vacuum-tube modulator shown, putting the transformer in series with the high-voltage supply. A transformer with a high turns ratio (100:1; such as a 10,000:8-ohm audio output) that is capable of withstanding a high voltage is adequate. High-voltage oscilloscope transformers work in the circuit.

(Continued on page 99)

*the tape that
turned the
cassette into
a high-fidelity
medium*



TDK SUPER DYNAMIC (SD) TAPE



TDK

Until TDK developed gamma ferric oxide, cassette recorders were fine for taping lectures, conferences, verbal memos and family fun—but not for serious high fidelity.

Today you can choose among high-quality stereo cassette decks.

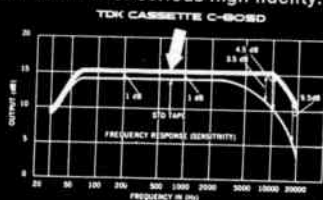

The new magnetic oxide used in TDK Super Dynamic tape distinctively differs from standard formulations in such important properties as coercive force, hysteresis-loop squareness, average particle length (only 0.4 micron!) and particle width/length ratio. These add up to meaningful performance differences: response capability from 30 to 20,000 Hz, drastically reduced background hiss, higher output level, decreased distortion and expanded dynamic range. In response alone, there's about 4 to 10 db more output in the region above 10,000 Hz—and this is immediately evident on any cassette recorder, including older types not designed for high performance. There's a difference in clarity and crispness you can hear.

Available in C60SD and C90SD lengths.

TDK ELECTRONICS CORP.
LONG ISLAND CITY, NEW YORK 11103

CIRCLE NO. 27 ON READER SERVICE CARD



We make the microphones, too.



So, if you purchase, operate, or use public address and audio-visual systems, either vocationally or avocationally, Shure microphones and related circuitry products can take many headaches out of your job. Modestly speaking, we are internationally known for our problem-solving microphones. Less well known, perhaps, is the fact that we've developed an entire array of ingenious, low-cost public-address circuitry products to solve dozens of pesky problems. These include nearly a dozen different modular, add-on *microphone mixers* . . . an *Audio Control Center* that actually matches audio response to the room acoustics . . . an effective *Audio Level Controller* . . . and plug-in problem-solvers to cure all sorts of knotty problems — instantly. Write:

Shure Brothers Inc.,
222 Hartweg Ave., Evanston, Ill. 60204



CIRCLE NO. 32 ON READER SERVICE CARD

Measurably Better!

MICRONTA® MULTITESTERS

Sold Only by Allied Radio Shack

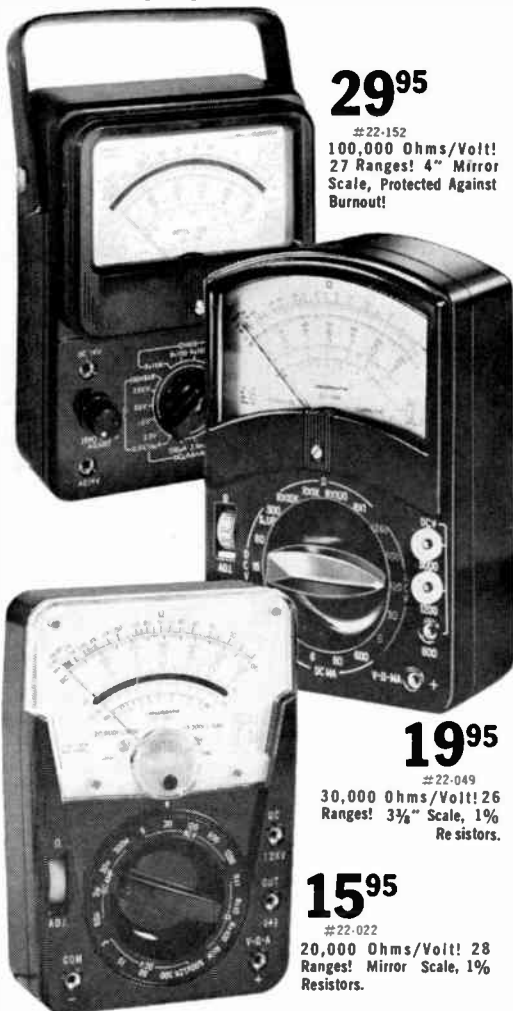

29⁹⁵

≡22-152
100,000 Ohms/Volt!
27 Ranges! 4" Mirror
Scale, Protected Against
Burnout!

19⁹⁵

≡22-049
30,000 Ohms/Volt! 26
Ranges! 3 1/4" Scale, 1%
Resistors.

15⁹⁵

≡22-022
20,000 Ohms/Volt! 28
Ranges! Mirror Scale, 1%
Resistors.

Factory wired VOM's (batteries & leads included!) at "kit" prices! See 'em at our 1000 stores. Find us, in almost every town and city, in the phone book. Or we'll ship anywhere in the USA postpaid.*

* Add State & Local Taxes if Applicable Where You Live

FREE!
Electronics
Catalog

ALLIED RADIO SHACK

A TANDY CORPORATION COMPANY

2725 W. 7th St. Fort Worth, Texas 76107

CIRCLE NO. 2 ON READER SERVICE CARD



To obtain a copy of any of the catalogs or leaflets described below, fill in and mail the Reader Service Card on Back Cover.

The Spring 1971 catalog available from *Tab Books* describes more than 170 current and forthcoming books. The 20-page illustrated catalog covers subject areas such as schematic/servicing manuals, broadcasting, CATV, electronics engineering, computer technology, audio and hi-fi, ham radio, test instruments, etc.

Circle No. 75 on Reader Service Card

Teac Corporation of America recently released an eight-page, full-color catalog describing the company's 201 series of hi-fi components. Listed and described are a stereo integrated amplifier, AM/stereo FM tuner, active crossover network, total performance indicator, stereo power amplifier, and a 3-way speaker system. Technical specifications for each item listed are provided.

Circle No. 76 on Reader Service Card

An illustrated 32-page catalog obtainable from *BEVCO* describes a complete line of quality imported hand tools and supplies for lapidarists, handcrafters, jewelers, and hobbyists. The listing includes a broad selection of anvils, hammers, scissors, drawplates, dapping dies, punches, gauges, burrs, etc. A section covering bench tools includes pliers, cutters, tweezers, screwdrivers, vises, saw frames, deburring tools, and files.

Circle No. 77 on Reader Service Card

Catalog No. CC-671 has just been issued by *Kepro Circuit Systems, Inc.*, supplier of circuit board and nameplate kits, materials, and tools. The new catalog provides condensed data and industrial net prices for more than 200 products of interest to industrial electronics design and packaging engineers, radio amateurs, experimenters, hobbyists, and students.

Circle No. 78 on Reader Service Card

University Mustang Speakers: spirited performance at a modest price.



Mustang Speakers, all 7 models, have heavy-duty steel and die-cast aluminum baskets which hold components to precision tolerances. Result: Mustang enjoys an amazingly low distortion factor. Mustang also has other features usually found only in more expensive speakers, such as its exclusive front or rear baffle mounting design,

seamless moulded cones, and electroplated mechanical structure. Their unique thin profile allows for easy installation in walls, ceilings, and limited space enclosures. Now you know some of the reasons why Mustang delivers pure sound for all high fidelity applications. Mustang is modestly priced from \$22.04 to \$76.94.



UNIVERSITY SOUND *DELIVERS!*

ALTEC Division of LTV Ling Altec, Inc.

1515 S. Manchester Avenue, Anaheim, California 92803

Write for free detailed University Sound Components Catalog

CIRCLE NO. 30 ON READER SERVICE CARD

CALL ME!



I'll send you 2 FREE BOOKS describing the opportunities in Electronics. Call me TOLL-FREE **800-321-2155** (in Ohio, call 800-362-2105).

For details about the famous CIE home-study courses in Electronics, see our ad on page 36

Cleveland Institute of Electronics
1776 East 17th Street, Cleveland, Ohio 44114

AR guarantees its published specifications

At Acoustic Research we believe that the publication of complete performance data on our high fidelity components is obligatory. Otherwise, our guarantee would have little meaning.

Find out just what AR guarantees that its products will do. Mail the coupon below, and detailed technical literature will be sent to you free of charge.



Acoustic Research, Inc.
24 Thorndike Street
Cambridge, Mass. 02141
Dept. PE-9

Please send measured performance data on AR products to

Name _____

Address _____

CIRCLE NO. 1 ON READER SERVICE CARD



BASICS OF CIRCUIT ANALYSIS FOR PRACTICING ENGINEERS

by Gordon E. Johnson

In this book, dc, ac, and complex frequency drives are considered as special cases of exponentially varying sinusoidal systems. A single analysis of an exponentially varying sinusoidal drive replaces the conventional treatments of other types of drives. Although the level of math used in the text does not go beyond elementary integral calculus, circuit theory is developed to the level necessary for the reader to continue study in related fields such as electronics, pulse techniques, and feedback control theory.

Published by Barnes & Noble, Inc., 105 Fifth Ave., New York, NY 10003. Soft cover. 258 pages. \$4.95.

PRINCIPLES OF COMMUNICATION SYSTEMS

by Taub & Schilling

A one-semester textbook for a senior-level under-graduate or a first-year graduate course in communication systems. It appears that every effort has been made to insure that the material presented in the text represents the present state of the art and point the direction of future developments. Accordingly, although analog communications systems are given full and complete treatment, the emphasis is on digital systems.

Published by McGraw-Hill Book Co., 330 West 42 St., New York, NY 10036. Hard cover. 514 pages. \$15.95.

RADIO-ELECTRONICS HOBBY PROJECTS

Here is a unique assortment of 32 electronic projects of practical value to almost any hobbyist or experimenter. For anyone who likes to build electronic gadgets, the editors of *Radio-Electronics* magazine have assembled projects for the audio buff, electronic musician, automobile owner, technician, and gadgeteer. While many of the projects presented can be built by the neophyte, there are others that the advanced experimenter will welcome. In addition to schematic diagrams and supportive text, the book is

Update your Radio/TV skills with these aids

Completely up-to-date, written by experts and easy to follow... they are "best sellers" to radio/TV technicians and amateurs alike.

COLOR-TV FIELD-SERVICE GUIDES

Invaluable for servicing Color-TV in the customer's home. Each volume contains 80 diagrams covering over 3,000 chassis... sensibly organized with detailed chassis layout charts on one page and specific adjustment procedures on opposite page. Indexed for instant reference

Vol. 1 No. 20796—\$4.95
Vol. 2 No. 20807—\$4.95
Vol. 3 No. 20847—\$4.95



TRANSISTOR AUDIO AMPLIFIERS

By Jack Darr

Gives you a good, working knowledge of transistor circuits found in audio equipment of all sizes. Shows how the circuits work normally, what changes take place when trouble occurs, and how to service the solid-state equipment. An invaluable guide for all who service transistor circuits No. 20838—\$5.50



1-2-3-4 SERVICING TRANSISTOR COLOR TV

By Forest H. Belt and Associates

Details the simple 1-2-3-4 servicing method and steps that get transistor Color-TV sets fixed easily and right every time. No. 20777—\$4.95



1-2-3-4 SERVICING AUTOMOBILE STEREO

By Forest H. Belt & Associates

Explains the simple 1-2-3-4 servicing method, shows how easy it is to apply the method to automobile stereo, fm multiplex, and tape cartridge systems. Clear, easy-to-read illustrations, charts and schematics to make servicing easy. No. 20737—\$3.95



STUDY GUIDE FOR CET EXAMINATIONS

By J. A. Wilson, CET and Dick Glass, CET

A comprehensive review of the material covered by the CET (Certified Electronics Technician) examination. It's almost a "must" for gaining a CET designation, for passing a state or local licensing exam, or as a "brush-up" in applying for a position in the electronics field. Includes question-and-answer sections and a 50-question test in each chapter. No. 20834—\$5.95



UNDERSTANDING OSCILLATORS

By Irving M. Gottlieb

What you want to know about oscillators... how they work, their many personalities and variations; strong and weak points, how they are used in practical applications, how to service them. A most useful text for engineers and technicians. No. 20837—\$4.50



99 ELECTRONIC PROJECTS

By Herbert Friedman

An intriguing, easy-to-follow book for hobbyists as well as those experienced in electronics. Covers sixteen groups of projects, including audio, photography, automotive, remote controls, lamp and motor control circuits, etc., many of which can be built inexpensively. No. 20818—\$3.50



101 QUESTIONS AND ANSWERS ABOUT CB ANTENNAS

By Jim Ashe

Best overall guide to the selection and installation of the proper antenna for your Citizens band radio. An ideal guide for beginners, it also answers questions about how to improve performance and range of already operating equipment and to repair and maintain CB antennas No. 20745—\$2.95



CITIZENS BAND RADIO HANDBOOK, 4th Edition

By David E. Hicks

Now that two-way radio is available to any citizen, this revised edition answers the many problems and questions of all who use, or plan to use, CB equipment. Covers how to obtain a CB license, operating procedures, equipment, accessories, circuit analysis, servicing data, trouble-shooting hints, etc. No. 20839—\$4.95



SECOND-CLASS RADIOTELEPHONE LICENSE HANDBOOK, 4th Edition

By Edward M. Noll

Information needed to pass the 2nd class FCC radiotelephone exam. Questions and answers are based on the FCC exam for Elements I, II and III. Also covers communications theory and practices, solid-state two-way equipment, FCC Rules and Regulations, operating practices and procedures, reference data, etc. No. 20824—\$6.50



You'll find everything you want to know about Radio or TV in the modern Sams Technical Library. Send for our free catalog.

HOWARD W. SAMS & CO., INC.

Order from your Electronics Parts Distributor, or mail to Howard W. Sams & Co., Inc., Dept. PE031 4300 West 62nd Street, Indianapolis, Indiana 46268.

Send books checked at right, \$_____ enclosed.

Please include sales tax where applicable.

Send FREE 1971 Sams Book Catalog.

Name _____ (Please Print)

Address _____

City _____ State _____ Zip _____

- | | |
|--------------------------------|--------------------------------|
| <input type="checkbox"/> 20796 | <input type="checkbox"/> 20834 |
| <input type="checkbox"/> 20807 | <input type="checkbox"/> 20837 |
| <input type="checkbox"/> 20847 | <input type="checkbox"/> 20818 |
| <input type="checkbox"/> 20838 | <input type="checkbox"/> 20749 |
| <input type="checkbox"/> 20777 | <input type="checkbox"/> 20839 |
| <input type="checkbox"/> 20737 | <input type="checkbox"/> 20824 |

Howard W. Sams & Co., Inc.
4300 W. 62nd St., Indianapolis, Ind. 46268

CIRCLE NO. 24 ON READER SERVICE CARD

HEAD STRONG



The Ampex AX-50 stereo tape deck has three of the strongest heads money can buy. Deep-Gap heads made to last 10,000 hours, without variance in gap or frequency response. Which is about 10 times longer than regular heads. That's strong!

The AX-50 is also strong on capabilities. With a heavy-duty hysteresis synchronous motor. Direct tape monitor. Pause/edit control. Echo effect. Function programmer for sound-on-sound and sound-with-sound. Stereo headphone jack. Plus many more features you must see . . . and hear.

You need a strong deck to pick up today's heavy sounds. And the AX-50 is the strongest in its price range.

\$249.95

(Suggested retail price)

AMPEX



THE SOUND IDEA PEOPLE

CIRCLE NO. 6 ON READER SERVICE CARD

LIBRARY (Continued from page 14)

well illustrated with PC board etching and drilling guides, assembly photos, and oscilloscope waveforms.

Published by Tab Books, Blue Ridge Summit, PA 17214. 192 pages. \$6.95 hard cover; \$3.95 soft cover.

RCA HIGH-SPEED, HIGH-VOLTAGE, HIGH-CURRENT POWER TRANSISTORS, PM-81

This newly revised manual is prepared primarily for designers, educators, and students. It contains the latest information on physical theory, structures, geometries, packaging, safe operating areas, thermal ratings, and operation of power transistors in linear and switching applications.

Published by RCA Solid State Div., Somerville, NJ 08876. Soft cover. 96 pages. \$2.00.

LABORATORY MANUAL FOR ELECTRIC CIRCUITS

by A.W. Avtgis et al

Another in the series of practical laboratory manuals prepared by the Wentworth Institute, this book is divided into four sections: design and analysis of a dc ammeter and voltmeter; the oscilloscope; RC transients; and output-input relationships of a frequency-dependent circuit with linear elements. A technician-level approach is used in the text.

Published by Prentice-Hall, Inc., Englewood Cliffs, NJ 07632. Soft cover. 137 pages. \$7.95.

TRANSISTOR AUDIO AMPLIFIERS

by Jack Darr

Whether large or small, transistor audio amplifiers are all remarkably similar in design and construction, and the servicing methods that work for one will work for the others. This book shows that the secret of successful servicing consists of knowing exactly how the circuit operates under normal conditions and what changes take place when a variance occurs. It begins with a discussion of basic transistor circuits and their voltages and currents under normal conditions. Then comes an explanation of the proper use of the best test equipment to use on audio amplifiers. Case histories of actual troubles are given to illustrate the approach to use.

Published by Howard W. Sams & Co., Inc., 4300 West 62 St., Indianapolis, IN 46268. Soft cover. 192 pages. \$5.50.

FREE!

1972 LAFAYETTE
CATALOG 720

**JUST OFF THE PRESS!!
SEND FOR YOUR EXCITING COPY NOW!**



Our 51st Year

**YOUR 1st GUIDE TO
EVERYTHING IN
ELECTRONICS**

1972
LAFAYETTE
CATALOG
720



The Latest in 4-Channel Stereo Sound

- ★ CITIZENS BAND 2-WAY RADIO
- ★ STEREO/HI-FI COMPONENTS
- ★ MUSICAL INSTRUMENTS AND AMPLIFIERS
- ★ PUBLIC ADDRESS
- ★ AMATEUR RADIO
- ★ TEST EQUIPMENT
- ★ PARTS
- ★ PORTABLE AND TABLE RADIOS
- ★ PHOTO EQUIPMENT
- ★ TOOLS-BOOKS
- ★ AUTO ACCESSORIES
- ★ EDUCATIONAL AND OPTICAL
- ★ TV AND ANTENNAS

Your Complete Buying Guide to Everything in Electronics

LAFAYETTE Radio ELECTRONICS
Dept. 35 091 P.O. Box 10
Syosset, L.I., N.Y. 11791

Mail the Coupon Today
for your FREE Lafayette
Catalog

Send me the FREE 1972 LAFAYETTE Catalog 35 091

Name

Address

City State

Zip (please include your Zip Code No.)

CIRCLE NO. 17 ON READER SERVICE CARD



**Train on this
315 sq. in.
picture
color TV
and get the
skills that
mean a
high-paying
career!**

Solid-State — the newest development

Count on NTS training to always feature the latest electronic equipment.

Now included in two exciting NTS color TV courses, this set is the largest, most advanced color television made. Guided by the NTS "Lab-Project Method" of combining professional kits and easy-to-follow lessons, you build this color TV step by step — learning TV Servicing as you go! NTS has successfully trained thousands of men at home for rewarding careers as electronics technicians. Prepare for the great opportunity fields of TV-Radio Servicing, Computers, Communications, and Automation.

This solid-state color set contains: 45 transistors, 55 diodes, 2 silicon controlled rectifiers, and 4 advanced Integrated Circuits representing an addi-

tional 46 transistors and 21 diodes. The first solid-state color TV this large — yours to keep! It features Automatic Fine Tuning; "Instant On"; an Ultra-Rectangular Screen (25 in. diagonal measurement) that lets you see the complete transmitted image for the first time — a full 315 square inches; exclusive built-in Self Servicing features which eliminate the need to buy costly test equipment; exclusive design Solid-State VHF Tuner with an MOS Field Effect Transistor; 3-stage Solid-State IF; Automatic Chroma Control; Adjustable Noise Limiting and Gate Automatic Gain Control; High Resolution Circuitry; Matrix Picture Tube; and a specially formulated Etched Face Plate that eliminates unwanted glare, and heightens contrast. Colors are more vivid,

fresh tones more natural, and the picture is sharper than ever before. By training on this unique color TV, you'll gain the most up-to-date skills possible in TV Servicing!

Other valuable equipment you build and keep includes an AM SW Radio, Solid-State Radio, FET Volt-Ohmmeter, and Electronic-Tube Tester. All included in your tuition. You learn troubleshooting, hi-fi, multiplex systems, stereo, and color TV servicing. Step right into a technician's job at top pay or open a business of your own! For complete details on all NTS electronics courses, mail the coupon today for the full-color NTS Catalog. No obligation. No salesman will call.

**Build this set
and learn
solid-state
circuitry—the
electronics
of today!**

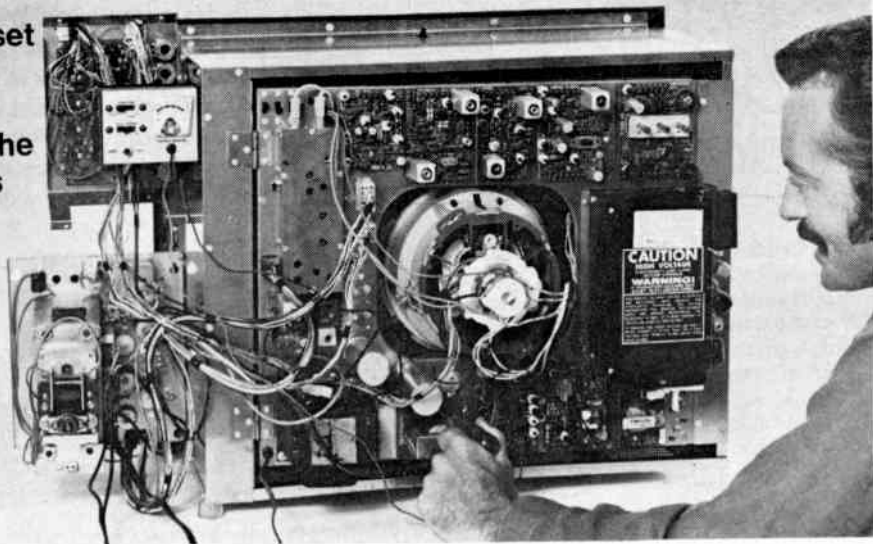

in color TV — comes to home training.

NTS ELECTRONICS & COMPUTER TECHNOLOGY

Build this exclusive NTS Compu-Trainer! Loaded with integrated circuits, it shows you the how, what, and why of computers. Learn this exciting field faster, more thoroughly. You also assemble and learn to operate an FET Volt-Ohmmeter and 5" wide band Oscilloscope.

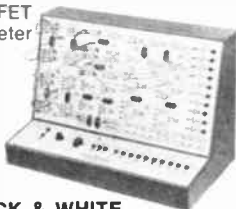

NTS BLACK & WHITE TV AND RADIO SERVICING

Learn all phases of television, radio, stereo, and hi-fi. You receive this 74 sq. in. picture Solid-State B&W TV, Lo-Silho "Superhet" Radio, FET Volt-Ohmmeter, Solid-State Radio, Electronic Tube Checker, and Signal Generator. Start earning extra money even before you complete the course!

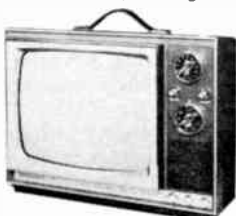

NTS ELECTRONICS COMMUNICATIONS & F.C.C.

Gain the security and prestige of owning an F.C.C. First Class Radio-Telephone License! Two comprehensive NTS courses cover the big opportunity field of transmitting and receiving. You build 14 kits, including a 5 watt AM Transceiver, 6 Transistor Pocket Radio, and FET Volt-Ohmmeter. Learn 2-way radio, Citizens Band, micro-waves and radar.



NTS INDUSTRIAL & AUTOMATION ELECTRONICS

Automation is the future of industry and you can play an important part! Learn industrial controls by training on the NTS Electro-Lab — a complete workshop. You also build and operate this 5" wide band Oscilloscope. And you perform experiments that involve regulating motor speeds, temperature, pressure, liquid level, and much more.



Classroom Training at Los Angeles. You can take classroom training at Los Angeles in sunny Southern California. NTS occupies a city block with over a million dollars in technical facilities. Check box in coupon.

APPROVED FOR VETERANS
Accredited Member: National Association of Trade & Technical Schools; National Home Study Council.

NATIONAL TECHNICAL SCHOOLS
WORLD-WIDE TRAINING SINCE 1905
4000 South Figueroa Street, Los Angeles, Calif. 90037

Please rush Free Color Catalog and Sample Lesson, plus information on course checked below. No obligation. No salesman will call.



National Technical Schools

4000 S. Figueroa St.
Los Angeles, Calif. 90037

- Master Course in Color TV Servicing
- Color TV Servicing (For Advanced Technicians)
- Master Course in B&W TV & Radio Servicing
- Master Course in Electronic Communication
- Practical Radio Servicing
- FCC License Course
- Master Course in Electronics Technology
- Industrial and Automation Electronics
- Computer Electronics
- Basic Electronics
- High School at Home Dept. 205-092

Name _____ Age _____

Address _____

City _____ State _____ Zip _____

Check if interested in Veteran Training under new G.I. Bill.
 Check if interested only in Classroom Training at Los Angeles.

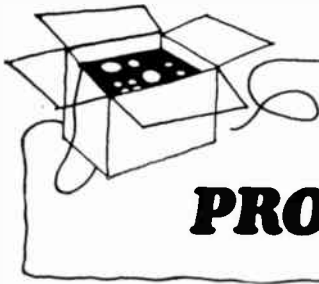

NEW PRODUCTS

Additional information on products described in this section is available from the manufacturers. Each new product is identified by a corresponding number on the Reader Service Page. To obtain additional information on any of them, circle the number on the Reader Service Page, fill in your name and address, and mail it in accordance with the instructions.

TECHNI-TOOL BELLOWS SYRINGE—Even the most inexperienced worker can now accurately dispense epoxy compounds, glues, and lubricants with *Techni-Tool Incorporated's* new plastic bellows syringe. The bellows design creates a series of 10 flutes each containing 3 cc of material. The bellows provides a no-drip (or suck-back) action for dispensing of light viscosity liquids. A long tapered tip design is employed for deep component potting.

Circle No. 79 on Reader Service Page 15 or 95



SONY/SUPERSCOPE AUTOMATIC-REVERSE TAPE DECK

—Sony's exclusive "Roto Bi-Lateral Head" is featured in the new Model 440 automatic-reverse stereo tape deck marketed by *Superscope, Inc.* The new tape head assembly contains record and playback heads and rotates 180° to provide recording, playback, and tape/source monitoring in both tape directions. The four-head Model 440 is thus capable of all of the functions of a six-head machine without the problems associated with six-head design. Another feature is the servo control motor which provides constant tape speed despite voltage or line-frequency changes. The standard features in the 440 include some that are found only in higher priced decks.

Circle No. 80 on Reader Service Page 15 or 95

GC ELECTRONICS "ULTRON" TV ANTENNAS—A new series of ultra-high-gain, all-channel TV receiving antennas were recently introduced by *GC Electronics*. The new "Ultron" antenna line includes three models: 32-1200 with 19 elements for metropolitan areas (\$9.95); 32-1202 with 21 elements for suburban areas (\$16.95); and 32-1204 with 29 elements and a totally different boom arrangement for fringe areas (\$24.95). All three are designed to cover the VHF and UHF TV bands as well as the FM broadcast band. They are said to have excellent ghost rejection and are suitable for both color and monochrome reception.

Circle No. 81 on Reader Service Card on Back Cover

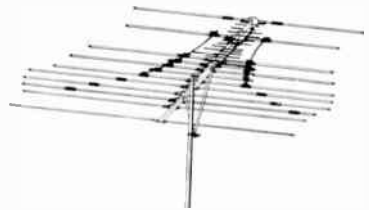

PIONEER CASSETTE TAPE DECK—High-fidelity sound hasn't always been associated with cassettes, but with the Model T-3300 high-performance tape deck from *U.S. Pioneer Electronics Corp.*, hi-fi and cassettes go hand in hand. Emphasizing exceptionally wide dynamic range, low wow and flutter, wide frequency response, and equipped with automatic tape stop, the T-3300 does not sacrifice either convenience or simplicity. The deck employs a precision hysteresis synchronous motor to produce non-deviating tonal reproduction and eliminate motor noise. Another feature you will find is a "pause"

The moving sound of moving sound.

The kind you get from Mallory's new light-weight, go everywhere cassette tape recorders.

They're pushbutton simple. And built to fit in with the excitement of living.

We have three solid-state models in three price ranges . . . something for everybody. And

they come with a whisper-sensitive dynamic microphone, automatic recording level circuit, power-packed Duracell® batteries and a full-fidelity Duratape® cassette.

Mallory portable cassette tape recorders . . . when you're going places.

MALLORY

MALLORY DISTRIBUTOR PRODUCTS COMPANY

a division of P. R. MALLORY & CO. INC.
Box 1558, Indianapolis, Indiana 46206; Telephone: 317-638-5253

MCR 1232

Total go-anywhere entertainment. Recorder and superb AM/FM radio. AFC, pop-up cassette ejector, built-in antenna. In a slim, tough case. The music-maker.

MCR 1204

Slim, neat, light. Battery operated. 3½" dynamic speaker and dynamic mike. For kids, teenagers . . . even Mr. Businessman.

MCR 1209

Great everywhere. Batteries or AC plug-in. Pushbutton operation. Slim, easy to carry, pack. Dynamic speaker and mike. The perfect gift.



Batteries • Capacitors • Controls • CRIME ALERT® • DURATAPE® Recorders Resistors • Semiconductors • SONALERT® • Switches • Timers

CIRCLE NO. 18 ON READER SERVICE CARD

NEW PRODUCTS

control for temporary stoppage of tape motion. In addition: slide-type record and playback controls, headphone jack, and DIN-type playback jack. Price \$149.95.

Circle No. 82 on Reader Service Card on Back Cover

EDMUND SCIENTIFIC COMPUTER KIT—A new working model electronic digital computer kit whose sophistication will provide a first-hand introduction to the real thing is available from *Edmund Scientific Co.* It can be programmed to perform many complex and simple operations. With the computer, the user can learn logic, gain a knowledge of decimal and binary systems, Laws of Sets, and even be able to do his own programming after reading the instructive 116-page booklet that accompanies the kit. With the assembled computer, the user can perform 39 different experiments, program it to solve simple or intricate math problems, play an infinite variety of games that are fun and instructive, etc. The kit is listed as Stock No. 71,434 and sells for \$31.50.

Circle No. 83 on Reader Service Card on Back Cover

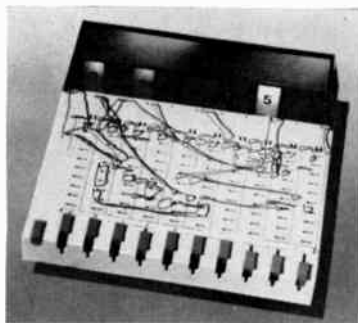

SHERWOOD DIGITAL READOUT STEREO FM TUNER—The *Sherwood Electronic Labs., Inc.*, Model SEL-300 stereo FM tuner is a striking example of forward thinking. The SEL-300 is a top-of-the-line tuner featuring a digital frequency readout instead of the usually standard slide-rule dial. Its computer accurate readout of station frequency is crystal-controlled. The readouts employed are the seven-segment incandescent type with an estimated life of 100,000 hours (almost 11.5 years of continuous operation). The technical specifications of the tuner and the descriptions of the parts and subassemblies used put the SEL-300 in the state-of-the-art category. Price \$579.

Circle No. 84 on Reader Service Card on Back Cover

SWITCHCRAFT "STUDIO MIXMASTER"—Sound-on-sound, sound-with-sound, mix, amplify, fade, switch—all are features of the new "Studio MixMaster" which has been introduced by *Switchcraft, Inc.* This Model 390-TR Mark VI convertible mixer was designed for both the audiophile and the sound contractor. It accepts up to three stereo inputs or stereo and mono combinations. Conversion from one operational mode to another is accomplished with fingertip action. The features also include individual channel gain controls, master output gain control, and right/left/both switching on each channel. Both phone and phono jack inputs are standard items.

Circle No. 85 on Reader Service Card on Back Cover



OLSON/TEABERRY CB TRANSCEIVER—Solid-state circuitry, dual-conversion receiver, illuminated power meter, and readiness to operate on all 23 channels are the features to look for in the "Five by Five" Teaberry CB-200 CB transceiver available from *Olson Electronics*. It has adjustable squelch, built-in TVI filter, and PA facilities. Supplied with the two-way radio are a push-to-talk mike, a mounting bracket, and a power cord. The transceiver operates on 12 volts dc, positive or negative ground. Price \$129.95.

Circle No. 86 on Reader Service Card on Back Cover

(More New Products on page 100)

Turner put a lot into the M+3 mobile microphone



Modu-Gard[®]

A compression amplifier circuit which prevents over modulation, ensures constant output always.

Slide-Action Volume Control

A transistorized pre-amplifier provides up to 15 db gain, now with new precision adjustment.

Modern Styling

An easy-to-grip design so distinctive it's patented.

Hypalon Cord

A matching blue coil cord with a memory; keeps its shape without stretching.

The Turner Name

A symbol for superior product design, manufacturing and quality control — made in USA.

You'll get a lot out of it.

TURNER DIVISION

CONRAC
CORPORATION

909 17th Street N.E.,

Cedar Rapids, Iowa 52402

(319) 365-0421

CIRCLE NO. 29 ON READER SERVICE CARD

9 new Heathkit Products



Ⓐ New Stereo/AM Portable...109.95*



Ⓑ New SWL Receiver...59.95*



Ⓒ New Cassette...119.95*



Ⓓ New Timing Light...19.95*



Ⓔ New Stereo-4 Decoder...29.95*



Ⓕ New Wireless Intercom...29.95*



Ⓖ New Garage Door Opener...99.95*

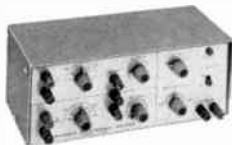

Ⓖ New Electronic Switch...39.95*



Ⓙ New Battery Charger...29.95*

See these kits at your local Heathkit Electronic Center

CALIF.: Anaheim, 330 E. Ball Road; El Cerrito, 6000 Potrero Avenue; La Mesa, 8363 Center Drive; Los Angeles, 2309 S. Flower St.; Redwood City, 2001 Middlefield Rd.; Woodland Hills, 22504 Ventura Blvd.; COLO.: Denver, 5940 W. 38th Ave.; GA.: Atlanta, 5285 Roswell Road; ILL.: Chicago, 3462-66 W. Devon Ave.; Downers Grove, 224 Ogden Ave.; MD.: Rockville, 5542 Nicholson Lane; MASS.: Wellesley, 165 Worcester St.; MICH.: Detroit, 18645 W. Eight Mile Rd.; MINN.: Hopkins, 101 Shady Oak Rd. MD.: St. Louis, 9296 Gravois Ave.; N.J.: Fair Lawn, 35-07 Broadway (Rte. 4); N.Y.: Jericho, L.I., 15 Jericho Turnpike; New York, 35 W. 45th Street; OHIO: Cleveland, 5444 Pearl Rd.; Woodlawn, 10133 Springfield Pike; PA.: Philadelphia, 6318 Roosevelt Blvd.; Pittsburgh, 3482 William Penn Hwy.; TEXAS: Dallas, 2715 Ross Avenue; Houston, 3705 Westheimer; WASH.: Seattle, 2221 Third Ave.; WIS.: Milwaukee, 5215 W. Fond du lac.

Retail Heathkit Electronic Center prices slightly higher to cover shipping, local stock, consultation and demonstration facilities. Local service also available whether you purchase locally or factory mail order.

...see 350 more in our new free catalog



(A) The new Heathkit Stereo/Phonograph with AM Radio gets it together in a portable package with a purple plum snakey skin that's as far out as today's sounds. Solid-state 18-watt amplifier, fold-down 4-speed automatic changer and swing-out high compliance speakers make it even better heard than seen. Speakers can be placed up to 5' away for maximum stereo separation. A flip of the mode switch and you're into AM radio! 45 spindle adapter included.
Kit GD-111, 50 lbs.109.95*

(B) The new Heathkit solid-state Shortwave Receiver is the perfect introduction to the world of shortwave listening. Four overlapping bands provide continuous coverage from 550 kHz to 30 MHz, giving you local AM plus international, amateur, marine & weather and citizens band broadcasts. Features bandspread tuning for close station separation; BFO control for receiving code; signal meter; front-panel headphone jack; noise limiter; built-in AM antenna.
Kit SW-717, 10 lbs.59.95*

(C) The New Heathkit Stereo Cassette Recorder, with a typical frequency response ± 3 dB, 30-12 kHz, brings your stereo system into the cassette age. Features include a built-in bias adjustment to accommodate the new chromium dioxide tape; counter; automatic motor shutoff; preassembled and aligned transport mechanism. The AD-110 permits full fidelity recording and playback of stereo or monaural through any quality hi-fi system.
Kit AD-110, 10 lbs.119.95*

(D) New Heathkit Automotive Timing Light has a flash so bright you can set up your car's ignition in the sunshine. Completely self-contained, just hook up 2 cables to the battery, 1 to the number one spark plug. A special adapter that permits connection to the distributor is included for cars with hard-to-reach plugs. Features balanced pistol-grip housing of high impact plastic that's impervious to oil, gas and corrosion — protects you from electrical shock.
Kit CI-1020, 2 lbs.19.95*

(E) New Heathkit Stereo-4 Decoder — It's the soundest approach to 4-channel reproduction yet! Compatible with your present stereo system and FM receiver, it lets you hear all Stereo-4 material currently being broadcast by a number of stations across the country. Additionally, it imparts a 4-channel effect to your existing stereo library. Requires second amplifier and 2 speaker systems for installation with conventional stereo system.
Kit AD-2002, 4 lbs.29.95*

(F) New Heathkit Solid-State Wireless Intercom — plug two of them into standard 105-130 VAC outlets in your home and you have a 2-way communications system! Three-channel capability lets you carry on 3 separate conversations in a 6-unit system, call one unit without disturbing the others in a 3-unit network. Individual intercoms have channel selectors, spring-loaded "talk" button, slide-action volume control, and "dictate" for extended one-way communication.
Kit GD-113, 5 lbs.29.95*

(G) New low cost Heathkit Garage Door Opener with all the heavy-duty features: strong chain-drive mechanism, 1/4-hp motor, automatic light, automatic safety reversing. Pocket size transmitter and solid-state receiver come preassembled, ready to use. The GD-309A easily operates all conventional single or double overhead doors up to 8' in height. Kit includes wall-mount switch, 1 transmitter, 1 receiver and door-opening mechanism.
Kit GD-309A, 43 lbs. 99.95*
Kit GD-309B, (w/2 transmitters) 43 lbs.114.95*
Kit GDA-309-1, (mech. only) 41 lbs. 69.95*

(H) The New Heathkit Electronic Switch provides simultaneous visual display of 2 input signals on a single trace oscilloscope. Has DC coupling and DC-5 MHz ± 3 dB frequency response. Conventional binding posts permit fast hook-up, and the ID-101 can be left connected to scope at all times, if desired. The ID-101 is ideally suited for digital circuit work; amplifier input and output for gain and distribution checks; simultaneous monitoring of 2 stereo channels.
Kit ID-101, 6 lbs.39.95*

(I) The New Heathkit Automatic Battery Charger is a lifesaver for 12-volt batteries in boats, farm equipment or infrequently used cars. Just plug into a standard 105-130 VAC outlet, hook up the positive and negative cables and leave it! It's virtually impossible to hook up wrong. If wires are crossed it simply won't start up. The GP-21 brings the battery to full charge then shuts down, maintaining just enough current to compensate for normal leakage. There are no charge settings to adjust, and you can leave it hooked up indefinitely for a fresh start every time!
Kit GP-21, 13 lbs.29.95*

Send for Free Catalog



HEATH COMPANY, Dept. 10-9
Benton Harbor, Michigan 49022

Enclosed is \$ _____, plus shipping.

Please send mode(s) _____.

Please send FREE Heathkit Catalog.

Please send Credit Application.

Name _____

Address _____

City _____ State _____ Zip _____

*Mail order prices; F.O.B. factory. CL-413

Prices & specifications subject to change without notice.

CIRCLE NO. 16 ON READER SERVICE CARD



**CAN'T FIND
PARTS FOR
SOLID-STATE
PROJECTS?**

**RCA Integrated Circuit Project Kits
eliminate that problem for
hobbyists, educators, technicians, hams.**

Stop running all over town trying to hunt up a part for your solid-state projects! Get RCA IC Project Kits—complete with active and passive components, predrilled printed-circuit boards, and easy-to-follow instructions.

As a matter of fact, RCA IC Project Kits are a convenient and inexpensive source for all kinds of circuits: from intruder- and fire-alarms to a 9-V regulated power supply, from amplifiers to marine-band converters.

See your RCA Distributor for the IC Project Kit of your choice. And while you're there, purchase the 368-page RCA Solid-State Hobby Circuits Manual, HM-91—it details over 60 interesting circuits, and includes a section on theory and operation of solid-state circuits.

RCA Electronic Components Harrison, N.J. 07029.

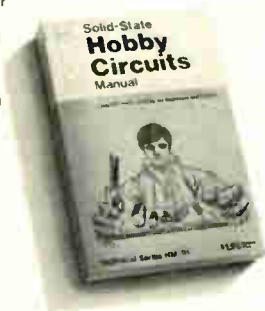

RCA

POPULAR ELECTRONICS

all american sports amplifier

HIGHLY SELECTIVE TV ANTENNA PREAMP BRINGS IN DISTANT STATIONS

COVER STORY

BY ROBERT B. COOPER, President
Community Antenna Development Co.

THERE COMES a time when the sports fan—especially the pro-football fan—wishes he could tune in on a TV station outside his immediate area. This happens when his favorite local pro team is playing at home and there is no local TV coverage.

Under the present federally sanctioned pro-football "blackout" television stations within 75 miles of the stadium are prevented from televising a home game; the reason being, of course, that local TV coverage might curtail gate attendance at the event itself.

The All American Sports Amplifier (AASA) described here has the ability to produce viewable television programs from stations 75 to 150 miles away from your receiver—provided it is driven by a properly designed and installed outdoor antenna. (See page 34.) Of course, the

AASA was not designed merely to "beat the TV blackout." Rather it is intended to improve substantially the reception from stations 75 to 150 miles away and in some cases, to make such reception a real possibility.

Since the signals from distant (up to 150 miles) stations are normally "here" but blocked out by stronger local signals, the trick to receiving them is to use a receiving system that filters out the strong local signals and amplifies the weak distant signals. That, in a nutshell, is what the AASA (with the proper antenna) does.

In practical terms, let's consider a situation where your locality has TV transmitters on (among others) channels 2 and 4. In your home, both channels are so strong that, when you tune to channel 3 and rotate your fine tuning control, you



Fig. 1. The highly selective amplifier for channels 2 through 6. The squared-off coils (called eL) are etched on the PC board. The channels are selected by choice of L1, L2, C1, C3, C6, and C8.

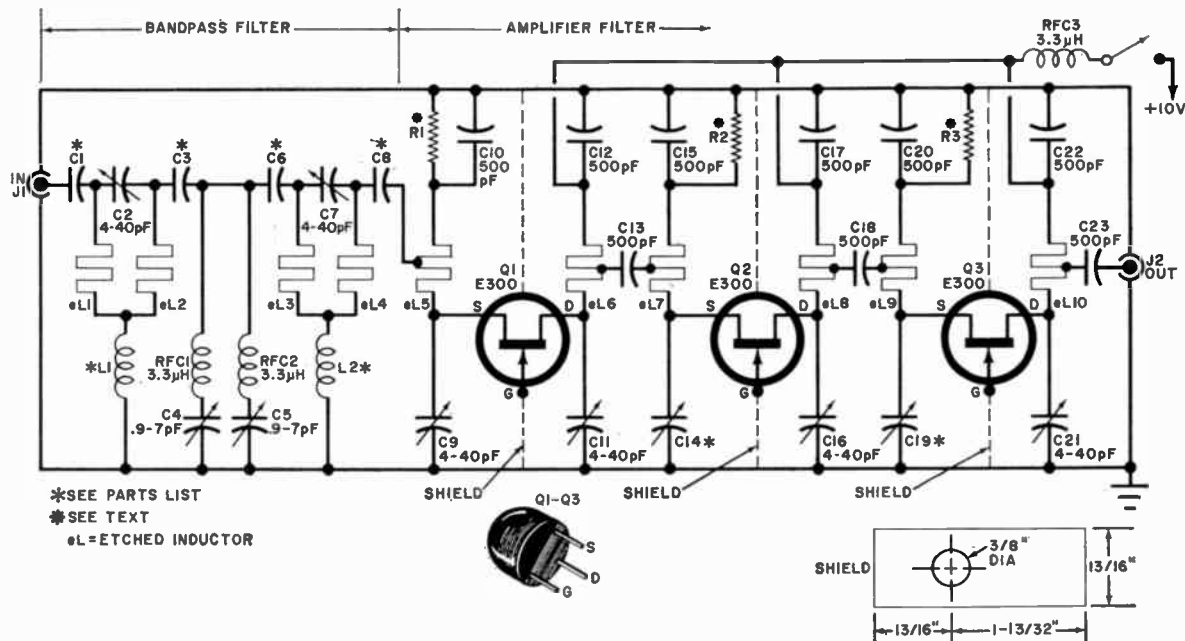

*SEE PARTS LIST
 #SEE TEXT
 eL=ETCHED INDUCTOR

PARTS LIST LOW-BAND AASA

- C1,C3,C6,C8—channels 2-4: 5.6-pF, 5% disc ceramic capacitor
 —channels 5-6: 4.7-pF, 5% disc ceramic capacitor
 C2,C7,C9,C11,C16,C21—4-40-pF trimmer capacitor (Elmenco/Arco 422)
 C4,C5—0.9-7-pF trimmer capacitor (Elmenco/Arco 400)
 C10,C12,C15,C17,C20,C22—500-pF uhf stud-mounting, feedthrough capacitor (Sprague BH-105, Centralab MFT)
 C13,C18,C23—500-pF, 10% disc ceramic capacitor
 C14,C19—channels 2-4: 9-180-pF trimmer ca-

- pacitor (Elmenco/Arco 463)
 —channels 5-6: 4-40-pF trimmer capacitor (Elmenco/Arco 422)
 eL1-eL10—Etched inductors on PC board
 J1,J2—G-F-59 F chassis mounting connectors
 L1,L2—channel 2: 9 turns #16, 5/16" form, close spaced with 0.2" mounting pigtails
 —channel 3: 7 turns same as above
 —channel 4: 5 turns same as above
 —channel 5: 6 turns same as above
 —channel 6: 5 turns same as above
 Q1-Q3—Field effect transistor (Siliconix E-300)
 R1-R3—91-560-ohm, 1/2-watt resistor (see text)

RFC1-RFC3—3.3- μ H molded choke (J. W. Miller 9310-24)

S1—Spst switch

Misc.—Suitable chassis, mounting hardware, interstage shields, etc.

Note—The following are available from CADCO, 4444 Classen Blvd., Oklahoma City, OK 73118: actual size foil pattern and component layout guide at \$2 (specify channel); etched and drilled circuit board LB24 (channels 2-4) or LB56 (channels 5-6) at \$10, postpaid; complete kit of all parts including power supply, pre-drilled mounting case, base plate, wooden end caps, prewound coils, E-300's with matched source resistors, LB24K or LB56K at \$37 plus postage for 4 lb. (Specify channel.)

receive a mixture of channel 2 sound and channel 4 picture. Both signals are overloading the receiver and bleeding into channel 3.

If you had a channel 3 antenna pointed at a 100-mile distant station, and either or both of channel 2 and 4 left the air while channel 3 was still transmitting, you would see a typical fringe signal: fairly weak, snowy, and fading up and down in level. With both channels 2 and 4 (or even just one of them) on the air, however, the bleeding would cover channel 3—even with a special antenna.

The AASA, installed between the antenna and receiver, filters out channels 2 and 4 (and all others except channel 3) and, at the same time, amplifies and filters channel 3. It reduces channels 2 and 4 levels by 20 to 50 dB and amplifies the channel 3 signal by 22 to 25 dB.

Since most television receivers have no more than 40 dB of adjacent channel rejection in their i-f strips, when your local station is 40 dB or more stronger than a distant one, the receiver is not capable of separating the two on adjacent channels. And, while any distant station needs amplification to be viewed comfortably, the receiver must "see" (from the antenna system) a better ratio of signal levels. Merely installing a signal booster and a cut-to-channel antenna for the distant signal is not enough since the booster amplifies the already strong local signals as well as the distant signal; and the existing ratio of signal levels between local and distant becomes more intolerable.

Construction and Alignment. The All American can be built for either the low channels (2 through 6) or the high ones (7 through 13). The respective schematics are shown in Figs. 1 and 2. A printed circuit board is required in either case and may be ordered as noted in the Parts Lists. (The foil pattern is too large to be reproduced here but may also be ordered from the source given in the Parts Lists.)

A schematic of the power supply is shown in Fig. 3. Assemble it as shown in Fig. 4.

For the low-band version, the values of L1 and L2 are determined by the distant channel you want to draw in. Study Figs. 5 through 7 carefully to determine component placement. Remember that

PATENT NOTICE

The All American Sports Amplifier (title copyright CADCO 1971) is covered by one or more patents pending with the U. S. Patent Office by the author. Individual (non-commercial) use of the designs and products covered here is permitted by the author and CADCO. Commercial use is the subject of numerous licensing agreements entered into by CADCO and/or the author, and all commercial rights are retained. "Interdigital Pre-Amplifier" and "Amplifilter" are registered trademarks of CADCO, Inc.

TECHNICAL SPECIFICATIONS LOW-BAND AASA

Total Gain: 22-25 dB
Noise Figure:* 3-4 dB
Bandwidth (± 0.25 dB): 4.5 MHz
Dynamic Range: 100 dB
Rejection lower adjacent aural,
upper adjacent visual carriers: 16-24 dB
Rejection lower adjacent visual,
upper adjacent aural carriers: 40-50 dB
Input/Output Impedance: 76 ohms,
unbalanced
Input Match: 16-18 dB
Output Match: 15-17 dB
Frequency Range LB24: 54-72 MHz
LB56: 76-88 MHz

HIGH-BAND AASA

Total Gain: 22-26 dB
Noise Figure: 5.0 dB
Bandwidth (± 0.25 dB): 5.0 MHz
Dynamic Range: 100 dB
Rejection lower adjacent aural,
upper adjacent visual carriers: 6-10 dB
Rejection lower adjacent visual,
upper adjacent aural carriers: 35-50 dB
Input/Output Impedance: 75 ohms, unbalanced
Input Match: 17-19 dB
Output Match: 15-17 dB
Frequency Range: 174-216 MHz

*Noise figure is computed as loss in the passive bandpass filter section plus electronic noise figure of first amplifier stage, as measured by a suitable noise figure test set.

lead dress and parts orientation are very important at these frequencies.

Begin by mounting the bandpass filter components (Fig. 5). An etched "R" ap-

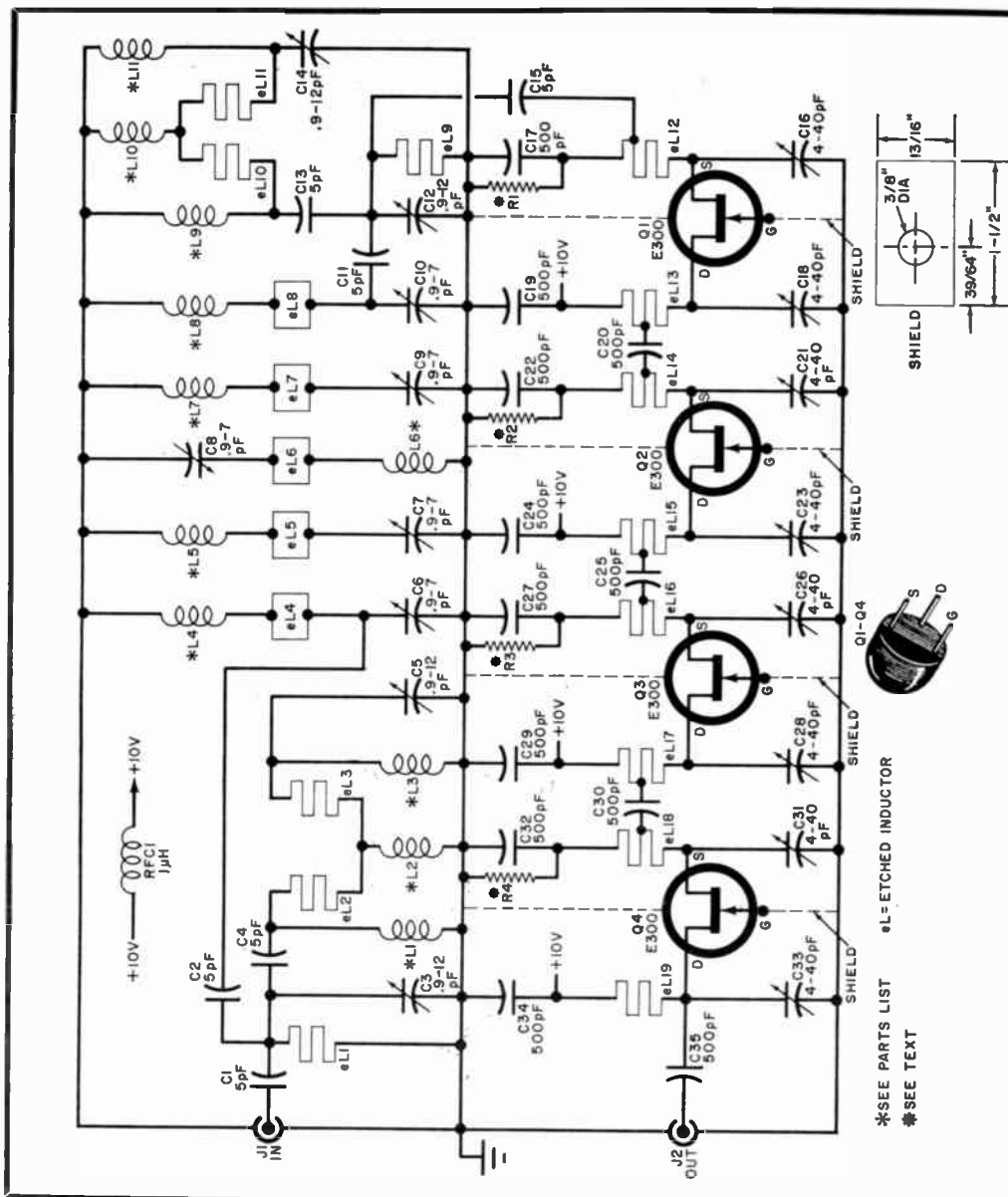

pears on the circuit board between the last filter section and the amplifier. Mount a temporary coaxial fitting here on a 1" piece of solder-tinned braid with the center of the coax connected to C8. This fitting will be used later in alignment. Solder the interstage shield down to the board ground with the transistor hole opposite the inner etched conductor (Fig. 6). Make sure that the shields are mounted at 90° to the board.

The vhf bypass capacitors (C10, C12,

C15, C17, C20, and C22) are mounted next. Note that these are really feed-through capacitors with two tips and a center ring. One tip goes to the connection dot on the etched inductor nearest the shield, while the bulge (ring) leans against the shield and is soldered to it. The opposite tip floats free.

The FET's are mounted in their holes in the shields with the gate lead facing the bypass capacitors. Use a heat sink on the FET leads when soldering. Mount the

PARTS LIST HIGH-BAND AASA

C1,C2,C4,C11,C13,C15—5-pF, 5% disc ceramic capacitor
 C3,C5,C12,C14—0.9-12-pF trimmer capacitor (Elmenco/Arco 402)
 C6-C10—0.9-7-pF trimmer capacitor (Elmenco/Arco 400)
 C16,C18,C21,C23,C26,C28,C31,C33—4.40-pF trimmer capacitor (Elmenco/Arco 422)
 C17,C19,C22,C24,C27,C29,C32,C34—500-pF, uHj stud-mounting, feedthrough capacitor (Sprague BH-105, Centralab MFT)
 C20,C25,C30,C35—500-pF, 10% disc ceramic capacitor
 eL1-eL19—Etched inductors on circuit board
 J1,J2—G-F-59 F chassis mounting connector
 L1,L4,L8,L10—4 turns, #16, 1/4" form, close spaced
 L2,L3,L9,L11—4 turns, #18, 3/16" form, close spaced
 Q1-Q4—Field effect transistor (Siliconix E-300)
 R1-R4—91-560-ohm, 1/4-watt resistor (see text)
 RFC1—1-uH choke (J. W. Miller 9310-12)
 Misc.—Suitable chassis, mounting hardware, interstage shields, etc.
 Note—The following are available from C.A.D.C.O. 4444 Classen Blvd., Oklahoma City, OK 73118: actual size foil pattern and component layout guide at S2 (specify channel); etched and drilled circuit board HB713 at S10 postpaid; complete kit of all parts including power supply, anodized pre-drilled case, base plate, wooden end caps, prewound coils, E-300's with matched source resistors, HB713K, at S41 plus postage for 4 lb. (Specify channel.)

Fig. 2. The selective amplifier for channels 7 through 13. Note the use of more extensive bandpass filtering.

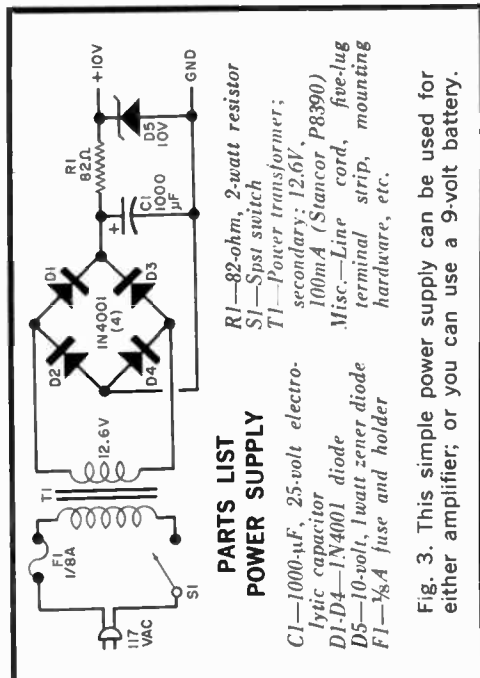

Fig. 3. This simple power supply can be used for either amplifier; or you can use a 9-volt battery.

Short jumpers are used to connect the power buss to the FET stages. Mount all components except for source resistors R1, R2, and R3. Performance curves for the E-300 FET call for 5 mA of current per stage for optimum noise figure and gain (with 9-to-10-volt operation). Connect a 10-mA meter in series with a resistor of 91 to 560 ohms. Connect the combination in the position for R1. Adjust the value of the resistor until the current is 5 mA. Use this resistor for R1. Do the same to determine the values for R2 and R3. Solder these resistors in place between ground and the outer dot on the etched inductor on the source side of the FET.

To align the bandpass filter, connect the antenna (aimed toward the distant station) to J1 and connect the temporary jack at C8 to the TV receiver. The fine tuning control on the receiver is very important now. In many cases it has not been used on this channel before and the local oscillator slug may have to be adjusted in the tuner. If your receiver has automatic fine tuning (aft), it must be disabled. Turn on the receiver. In most cases, you will have "spillover" from the adjacent channels. Using a plastic alignment tool, loosen the rotors on C4 and C5 to minimum capacitance. Adjust C2 and C7 to get maximum signal from the distant station. (You may have only sync bars to work with.) Adjust the receiver fine tuning for best reception. Slowly increase the capacitance of C4 (screw in)

six input-output trimmers (C9, C11, C14, C16, C19, and C21) using the leaf terminal as the rotor and soldering it to ground. The stationary terminal is soldered to the dot on the inner end of the etched inductor. Solder the FET source and drain leads to the appropriate trimmers, using a heat sink.

The interstage coupling capacitors are installed using Table I for proper tap points. Keep the leads as short as possible.

CHOOSING AN ANTENNA FOR THE ALL AMERICAN

When it comes to picking up a distant TV station, most people think it is only necessary to rotate their present antenna in the direction of the station and maybe hook up some type of signal booster. However, if you attempt this, you will most likely find that you still don't have much in the way of a useful signal. The rules given here for choosing and installing an antenna for the All American Sports Amplifier are equally applicable to any situation involving the reception of distant signals.

Station Selection. Probably more than one station within a 75- to 150-mile range carries the program of interest. A low-band (channels 2 through 6) station is a better choice than one in the high band (7 through 13) because most TV sets have better selectivity and sensitivity at the low end. In addition, low-band signals tend to fill in behind buildings, hills, and trees better than the high-frequency signals. Low-band signals are probably at a higher level at a distance than high-band signals. In many cases, a low-band station 100 miles off may well be a better choice than a high-band one that is 75 miles away.

Antenna Selection. The best antenna for a single channel is the single-channel yagi, with all of its parameters optimized for that one channel. Virtually all antenna manufacturers have such items in their line. Here are the preferred configurations:

Distance to station	Channels 2-6	Channels 7-13
75 miles	5-element, 40-50 feet high	10-element, 40-50 feet high
100 miles	10-element, 40-50 feet high	10-element, 60 feet high
125 miles	Stacked 5-element, 50-60 feet high	Stacked 10-element, 60 feet high
150 miles	Stacked 10-element, 60 feet or higher	4 stacked 10-element, 60-70 feet high

Antenna Orientation. Since a single-channel yagi is very directional, try to choose a distant station that lies in a different direction from your local TV outlets. The built-in directional pattern of the yagi can greatly assist in the rejection of the local stations. All directional antennas have a maximum pickup from their front and minimum pickup on each side. Do a little map reading and carefully choose the best direction for your purpose.

Antenna Height. A typical suburban neighborhood is described as being 35 or 40 feet "tall"—the height of most residential buildings, utility poles, trees, etc. Anything below that level is described as being in the "clutter level." So, unless your house is on a hill, your antenna

**TABLE I
TAP POINTS FOR ETCHED INDUCTORS**

Channel	eL5	eL6	eL7	eL8	eL9	eL10
2	4 out	outside	2 out	outside	2 out	2 in
3	"	"	"	"	"	"
4	"	"	"	"	"	outside
5	2 out	1 in, side	2 out	1 in, side	2 out	outside
6	"	"	"	"	"	3 in, corner
	eL12,eL16	eL14,eL18	eL13,eL15,eL17,eL19			
7-13	2 out	1 out	outside			

Note: Input inductors eL5, eL7, eL9 (low-band) and eL12, eL14, eL16, eL18 (high-band) start the inductor turn count on the inside (center) and count out with the first full turn (not the partial final inner turn) as turn number one, etc. Output inductors eL6, eL8, eL10 (low-band) and eL13, eL15, eL17, eL19 (high-band) start the inductor turn count on the outside and count in with the outer most turn being number 1.

must be above the clutter level. A large antenna 20 feet above the ground is not as good as a smaller one 40 feet up, simply because the height brings freedom from signal absorption by the surroundings. Once you get above the clutter, signal reception improves slowly until the antenna is 60 or 70 feet up, where reception begins to improve markedly again.

Antenna Installation. Be sure that you know the impedance of both the antenna and your TV set and use a good quality low-loss transmission line of suitable impedance. If necessary, use a matching transformer at one or both ends to get the correct impedance matching. Remember that there are both indoor and outdoor (weatherproof) matching transformers.

Incidentals. Before mounting a high antenna, be sure that the ends of the elements are closed to avoid the "pipe organ effect"—wind blowing past the open tube and causing it to hum. This can be very annoying when the antenna mast transmits the noise to the roof of the house.

Use guy wires when the antenna is 15 or 20 feet high. The cost of guy wires is small compared to that of a good antenna. Waterproof the connection between the transmission line and antenna to avoid electrolysis and wind damage.

Another good tip is to connect a 100,000-ohm resistor across the antenna before you put it up. Then all you need is an ohmmeter to test the circuit from the

TV receiver to the antenna without lowering the antenna. The high resistance value will not affect the antenna's performance.

Rotators are always useful for locating distant signals. Sometimes the signal may not be the strongest when it comes directly from the station. Reflections from a hill or tall building may be stronger. There is more than one case of a signal being bounced off a hilltop roadside billboard (having a metal backing) to be received down in the valley.

If you do your own TV servicing, try different tubes (of the same type naturally) in front-end and first i-f amplifier. This is where the bulk of the snow comes from, and having a couple of extra tubes permits you to select the one with the lowest noise. (Unfortunately, you can't do this easily if your set is all solid state.)

In using an old TV receiver for distant reception (and if you have the test gear), try reducing the bandwidth, which increases the gain. A less snowy 2.5-MHz picture is better than a snowy 3.5-MHz one. Be sure that the other tubes in the set are up to snuff, especially in the i-f strip where all the signal gain occurs.

Don't use staples to hold the transmission lines. You can damage an internal conductor or change the impedance. Use the mounting procedure recommended by the cable manufacturer. Finally, don't forget to waterproof the hole where the line enters the house. Your team may lose but you'll still have a dry floor.

(Text continued on page 40)

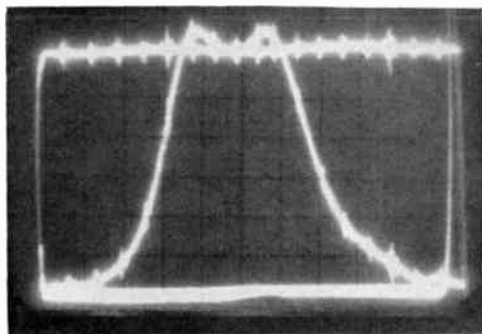

Channel 3 circuit without traps showing the channel 2 aural and channel 4 visual markers down the skirt, such carriers cause interference.

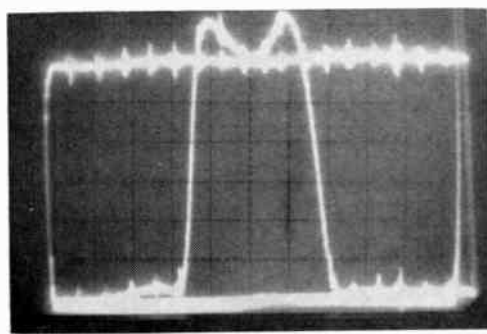

Here is the same channel 3 circuit with its adjacent channel double traps installed. Note the sharpened bandpass characteristic and vastly improved adjacent channel rejection.

How to get into One of the hottest money-making fields in electronics today— servicing two-way radios!



HE'S FLYING HIGH. Before he got his CIE training and FCC License, Ed Dulaney's only professional skill was as a commercial pilot engaged in crop dusting. Today he has his own two-way radio company, with seven full-time employees. "I am much better off financially, and really enjoy my work," he says. Read here how you can break into this profitable field.

More than 5 million two-way transmitters have skyrocketed the demand for service men and field, system, and R&D engineers. Topnotch licensed experts can earn \$12,000 a year or more. You can be your own boss, build your own company. And you don't need a college education to break in.

HOW WOULD YOU LIKE to start collecting your share of the big money being made in electronics today? To start earning \$5 to \$7 an hour... \$200 to \$300 a week... \$10,000 to \$15,000 a year?

Your best bet today, especially if you

don't have a college education, is probably in the field of two-way radio.

Two-way radio is booming. Today there are more than *five million* two-way transmitters for police cars, fire department vehicles, taxis, trucks, boats, planes, etc. and Citizen's Band uses—

and the number is still growing at the rate of 80,000 new transmitters per month.

This wildfire boom presents a solid gold opportunity for trained two-way radio service experts. Many of them are earning \$5,000 to \$10,000 a year *more* than the average radio-TV repair man.

Why You'll Earn Top Pay

One reason is that the United States Government doesn't permit anyone to service two-way radio systems unless he is *licensed* by the Federal Communications Commission. And there simply aren't enough licensed electronics experts to go around.

Another reason two-way radio men earn so much more than radio-TV service men is that they are needed more often and more desperately. A home radio or television set may need repair only once every year or two, and there's no real emergency when it does. But a two-way radio user must keep those transmitters operating at all times, and *must* have their frequency modulation and plate power input checked at regular intervals by licensed personnel to meet FCC requirements.

This means that the available licensed experts can "write their own ticket" when it comes to earnings. Some work by the hour and usually charge at least \$5.00 per hour, \$7.50 on evenings and Sundays, plus travel expenses. A more common arrangement is to be paid a monthly retainer fee by each customer. Although rates vary widely, this fixed charge might be \$20 a month for the base station and \$7.50 for each mobile station. A survey showed that one man can easily maintain at least 100 stations, averaging 15 base stations and 85 mobiles. This would add up to at least \$12,000 a year.

Be Your Own Boss

There are other advantages too. You can become your own boss—work entirely by yourself or gradually build your own fully staffed service company. Instead of being chained to a workbench, machine, or desk all day, you'll move around, see lots of action, rub shoulders with important police and fire officials and business executives who depend on two-way radio for their daily operations. You may even be tapped for a big job working for one of the two-way radio manufacturers in field service, factory quality control, or laboratory research and development.

How To Get Started

How do you break into the ranks of the big-money earners in two-way radio? This is probably the best way:

1. Without quitting your present job, learn enough about electronics fundamentals to pass the Government FCC Exam and get your Commercial FCC License.
2. Then get a job in a two-way radio service shop and "learn the ropes" of the business.
3. As soon as you've earned a reputation as an expert, there are several ways you can go. You can move *out* and start signing up and servicing your own customers. You might become a franchised service representative of a big manufacturer and then start getting into two-way radio sales, where one sales contract might net

you \$5,000. Or you may even be invited to move *up* into a high-prestige salaried job with one of the major manufacturers either in the plant or out in the field.

The first step—mastering the fundamentals of Electronics in your spare time and getting your FCC License—can be easier than you think.

Cleveland Institute of Electronics has been successfully teaching electronics by mail for over thirty years. Right at home, in your spare time, you learn electronics step by step. Our AUTO-PROGRAMMED® lessons and coaching by expert instructors make everything clear and easy, even for men who thought they were "poor learners." You'll learn not only the fundamentals that apply to all electronics design and servicing, but also the specific procedures for installing, troubleshooting, and maintaining two-way mobile equipment.

Get Your FCC License... or Your Money Back!

By the time you've finished your CIE course, you'll be able to pass the FCC License Exam with ease. Better than nine out of ten CIE-trained men pass the FCC Exam the first time they try, even though two out of three non-CIE men fail. This startling record of achieve-

ment makes possible the famous CIE warranty: you'll pass the FCC Exam upon completion of your course or your tuition will be refunded in full.

Ed Dulaney is an outstanding example of the success possible through CIE training. Before he studied with CIE, Dulaney was a crop duster. Today he owns the Dulaney Communications Service, with seven people working for him repairing and manufacturing two-way equipment. Says Dulaney: "I found the CIE training thorough and the lessons easy to understand. No question about it—the CIE course was the best investment I ever made."

Find out more about how to get ahead in all fields of electronics, including two-way radio. Mail the bound-in postpaid reply card for two FREE books, "How To Get A Commercial FCC License" and "How To Succeed In Electronics." If card has been removed, just mail the coupon below.

NEW REVISED G.I. BILL BENEFITS:

All CIE courses are approved for full tuition reimbursement under new G.I. Bill. If you served on active duty since Jan. 31, 1955, OR are in service now, check box on reply card or coupon for G.I. Bill information.

CIE Cleveland Institute of Electronics
1776 East 17th Street, Cleveland, Ohio 44114

2 New CIE CAREER COURSES

1. **Electronics Technology with Laboratory . . .** Teaches you the fundamentals. With a 161-piece laboratory you apply the principles you learn by analyzing and troubleshooting electronics equipment.

2. **Electronics Engineering . . .** Covers steady-state and transient network theory, solid state physics and circuitry, pulse techniques, computer logic and mathematics through calculus. A college-level course for men already working in Electronics.

Cleveland Institute of Electronics
1776 East 17th Street, Cleveland, Ohio 44114

Please send me without cost or obligation:
Your new illustrated 44-page book, "How To Succeed in Electronics."
Your book on, "How To Get a Commercial FCC License."

I am especially interested in:

- Electronics Technology Electronic Communications
 Broadcast Engineering Industrial Electronics
 First Class FCC License Electronics Engineering
 Electronics Technology with Laboratory

Name _____
(PLEASE PRINT)

Address _____

City _____

State _____ Zip _____ Age _____

Veterans & Servicemen: check here for latest G.I. Bill information.

Accredited Member National Home Study Council

PE-20

CIRCLE NO. 11 ON READER SERVICE CARD

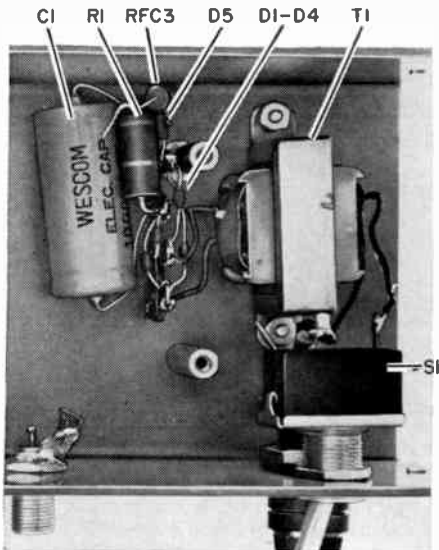

Fig. 4. The power supply can be tucked into one corner of the metal cabinet.

until the signal from the lower adjacent channel is a minimum. Adjust $C5$ to get the same effect on the upper adjacent channel. Readjust the fine tuning and the other filter capacitors to get the best remote picture. Remove the temporary connector from $C8$ and connect $C8$ to its tap on $eL5$.

Connect the TV receiver to output jack $J2$ and turn on all power. Using an insulated alignment tool, adjust $C11$, $C16$, and $C21$ for maximum distant signal reception. Then adjust $C9$, $C14$, and $C19$ for the same effect. Trimmers $C9$, $C14$, and $C19$ affect the flatness of the bandpass

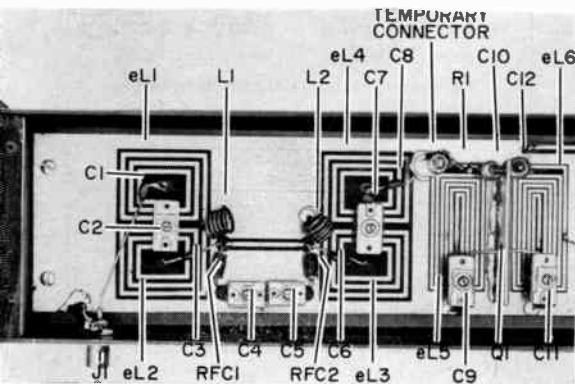

Fig. 5. Component installation at input end of low-band unit shows temporary connector.

curve (best sound and picture together), while $C11$, $C16$, and $C21$ affect the total gain. If absolutely necessary, you may have to readjust $C4$ and $C5$ slightly to reduce any adjacent channel interference. The alignment process can be performed faster and easier if you have an r-f sweep generator and a scope.

Component installation for the high-band All American is shown in Figs. 8 through 10. The same precautions must be used in assembly as were described for the low-band version.

Alignment of the high-band bandpass filter is a little tricky. Temporarily connect an output coaxial connector to point R on the board with the center conductor connected to the output of $C11$. Tempo-

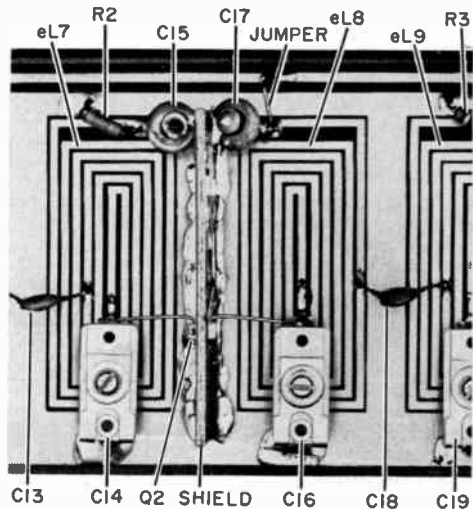

Fig. 6. The mid-section of the low-band amplifier showing how the bypass capacitors and the jumper for the FET power are connected.

rally disconnect $C1$ from $J1$ and connect $C2$ to $J1$. With the antenna connected to $J1$ and properly aimed and with the TV receiver connected to the temporary output from $C11$, adjust $C6$ and $C10$, then $C7$, $C8$, and $C9$ for maximum reception of the distant signal.

Reconnect $C1$ and $C2$ as shown in the schematic and connect the temporary output to $C15$. Adjust $C3$ and $C5$ for minimum lower adjacent channel bleed and $C12$ and $C14$ for minimum upper channel bleed. Retouch $C7$, $C8$, and $C9$ for best reception. Reconnect $C15$ according to the schematic. Now the entire circuit is

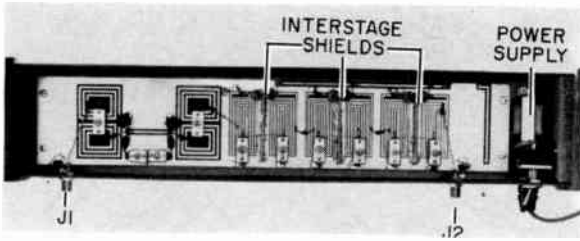

Fig. 7. Overall view of the low-band amplifier showing shields.

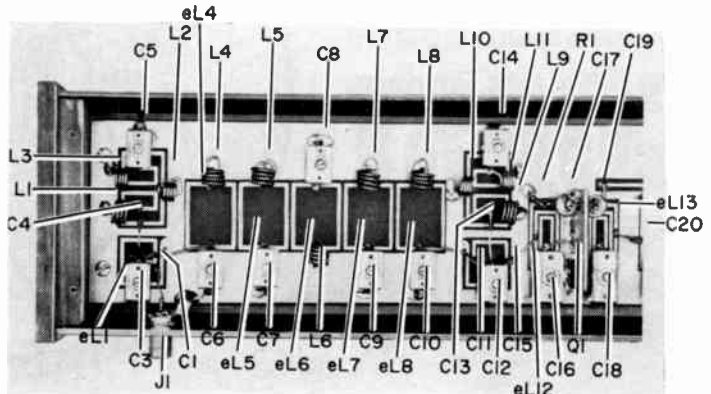

Fig. 8. Input end of the high-band amplifier showing component placement. Note the five mutually coupled etched-circuit coils.

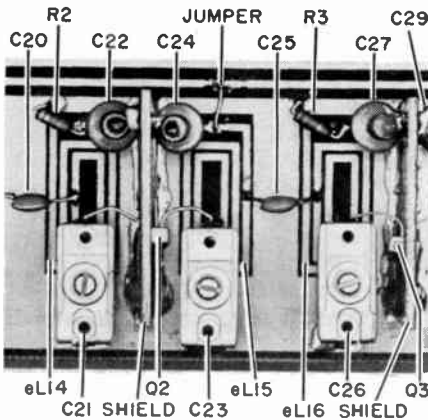

Fig. 9. Mid section of the high-band board showing components.

in operation. With power applied, adjust C18, C23, C28, and C33 for maximum signal. Then adjust C16, C21, C26, and C31 for best reception.

Theory of Circuit Design. In the low-band version of the All American (Fig. 1), the 75-ohm antenna line is connected to a three-section bandpass filter. The first section is composed of C1, C2, C3, eL1, eL2, and L1; the third is C6, C7, C8, eL3, eL4, and L2. Between these are two series trap circuits; RFC1-C4 traps out the lower adjacent channel and RFC2-C5 traps out the upper adjacent channel. The combined filters permit only the selected channel to pass and severely attenuate

(Continued on page 98)

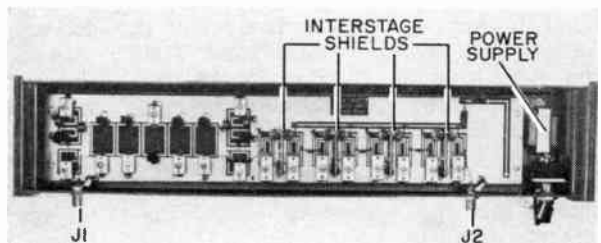

Fig. 10. Overall view of the high-band board showing the shields.

CB and the COAST GUARD



WHEN IT COMES TO MARINE SAFETY, LACK OF
MEN AND MONEY IS PREVENTING THE COAST GUARD
FROM COMPLYING WITH CB'ERS PLEAS

There are two very good reasons why almost everyone in U. S. Coast Guard communications turns "international orange" whenever the 27-MHz class D Citizens Band is mentioned: lack of men and lack of money.

The Manpower Problem. This is pretty obvious. During a radioman's six-hour stint at the console of the average Coast Guard shore station, he must listen simultaneously to 2182 kHz (the International Calling & Distress frequency in the 2-3-MHz marine band), 156.8 MHz (the American or "National" Distress, Safety & Calling frequency in the 156-162-MHz VHF/FM marine band), 2670 kHz (the 2-3-MHz "Coast Guard-Civilian" channel for routine non-emergency traffic), and the respective USCG District's working frequency (2662 kHz, for

instance, in the 3rd USCG District). That means there are times when conversations on all four channels are assaulting his ears. It's at its worst during the summer boating months.

Captain Charles Dorian, who was then Chief of Coast Guard communications, said (in effect) as long ago as 1965, "We have already passed the limits of human endurance. Asking a radioman to monitor yet another frequency (the oft-suggested CB Coast Guard channel) is just too much."

In addition to his listening-watch duties, the radioman must accurately log all traffic between his station and others; he is responsible for sending and receiving teletype messages if his station is in command of a group of stations; he must be ready to grab the "hot-line" telephone, which can come to life at any

moment; and when he transmits on any of the four frequencies that he's required to monitor, he must keep his ear tuned for important traffic on the other three at the same time. Ask this man to monitor a fifth channel and he'd probably staple your fingers together.

Requests Keep Coming. But the requests and petitions to have the Coast Guard maintain a listening watch on a CB channel still persist. This is not to say that anyone who brings up the subject is a "bad father." In fact, there is a certain amount of justification for the request. Many boat owners, put off by the comparatively higher cost of 2-3-MHz and VHF/FM marine radiotelephones, have had to resort to inexpensive CB equipment.

The hang-up in pressing certain 27-MHz frequencies into service as a marine communications service is that they don't have marine operator facilities for ship-to-shore phone calls, they have no universally agreed upon channels for ship-to-ship communications, and, of course, no recognized marine distress

frequency is monitored by the Coast Guard. It's this last one that the boating CB'er misses the most. While he may feel he can get along without the marine operator and he and the boys can get together and decide what channel they'll use for ship-to-ship communications, he'd sure like to be able to call the Coast Guard on a Citizens Band channel if he gets into trouble.

Some Drawbacks. While sympathetic, the Coast Guard points out that there are two marine bands already available to the pleasure-boat owner and cites some CB disadvantages. The low 5-watt input limitation means that the range is usually restricted. But when the skip is in on this remake of the old eleven meter ham band, signals from Toledo to Tobago bounce in at S-9 plus on all channels—and this would undoubtedly include our hypothetical distress channel. The Coast Guard respectfully submits that it doesn't deserve this.

By far the most important drawback in creating a maritime distress frequency in the CB band is the international phil-

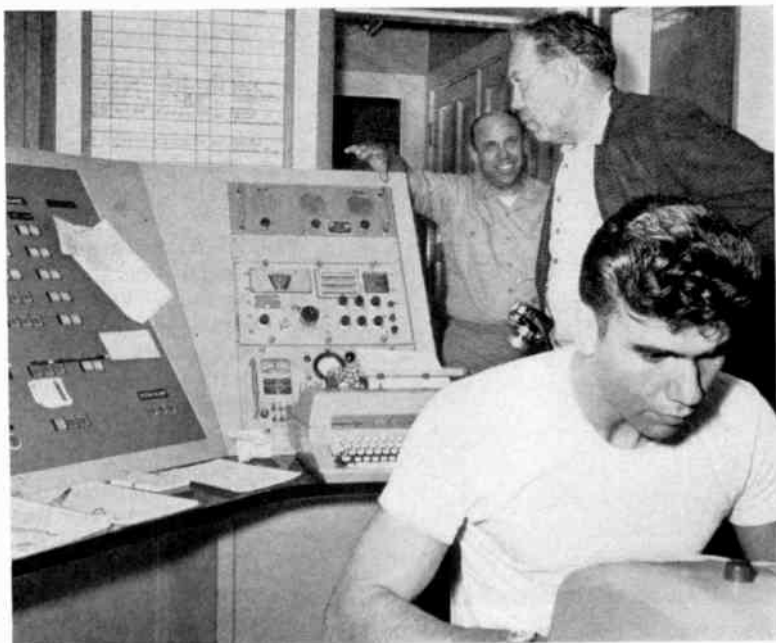

LCDR C. R. Hinrichs explain duties of radioman (in foreground at teletype) at Eaton's Neck (N.Y.) Coast Guard Station to a visitor. In addition to monitoring four radio channels, man on duty must keep track of several radio-controlled lighthouses. (Coast Guard Photo)

osophy that a distress channel shall be monitored by all licensees at all times during their hours of service. For instance, all base and mobile stations are required to maintain a listening watch on 500 kHz (the international CW distress frequency), 2182 kHz (international voice), 121.5 MHz (international aeronautical) and (in American waters only) channel 16 (156.8 MHz) in the VHF/FM marine band.

This means that, if a CB channel were to be officially designated a distress (Coast Guard) frequency, all marine CB'ers could be required to monitor it as long as their sets were turned on.

Finally, if such a frequency were to become a reality, marine operators and ship-to-ship service would probably not be long in coming. This means that the Coast Guard, the Federal Communications Commission, the communications industry and the organizations representing it, and other vested and private interests would become involved in lengthy rule-making procedures. Then, if it went through, you'd still have a low-power, skip-frequency communica-

tions service that is already up to its knickers in interference and congestion.

It would be far better, according to the many Coast Guard officials interviewed, to let maritime CB go along just as it is—an adjunct to conventional marine communications. The marine radiotelephone is a safety device. A CB installation for "chatter" use would serve a valuable function in relieving the marine bands of non-safety traffic, and thereby, of much of the congestion and interference during the boating season.

It must be pointed out that the Coast Guard doesn't hate CB in and of itself. It's just that anything connecting or involving the Coast Guard officially with CB is what gives it the shivers. As a matter of fact, the National Search & Rescue School, which has the responsibility of training key men in all aspects of search and rescue, lists Citizens Band groups as one of the important civilian aids to be called upon by Rescue Coordination Centers, Coast Guard officials and Civil Air Patrol people for help in search and rescue missions both on land and at sea.

In essence, the situation is that the U. S. Coast Guard is undermanned and underfinanced. Its entire strength is under 40,000—only a few thousand more than the New York City Police Department. With this manpower, the Coast Guard must staff every icebreaker this country owns; maintain and man loran stations all over the world; crew the many ocean station vessels on watch in the Atlantic and Pacific as part of our commitments to the International Civil Aviation Organization; fulfill requirements in oceanography, law enforcement, port security; and, its prime function, perform search and rescue operations.

Financing these activities is a perennial touch-and-go proposition. (The Coast Guard's budget for fiscal 1971 wasn't approved until a few weeks before the end of the period.) So they must obviously keep a constant eye on priorities and squeeze the last drop of efficiency from every man and every dollar. Each tool it uses must be the best available for the job. A Coast Guard monitored distress frequency on the CB band, many feel, is far from being the best tool for the purpose. ♦



Radioman at Rockaway (N.Y.) USCG Station has hurried look as he nears end of 6-hour duty. Receiver at top of panel continually monitors 2182 kHz and has switch knob removed to prevent accidental switching away from distress channel. (Coast Guard Photo)

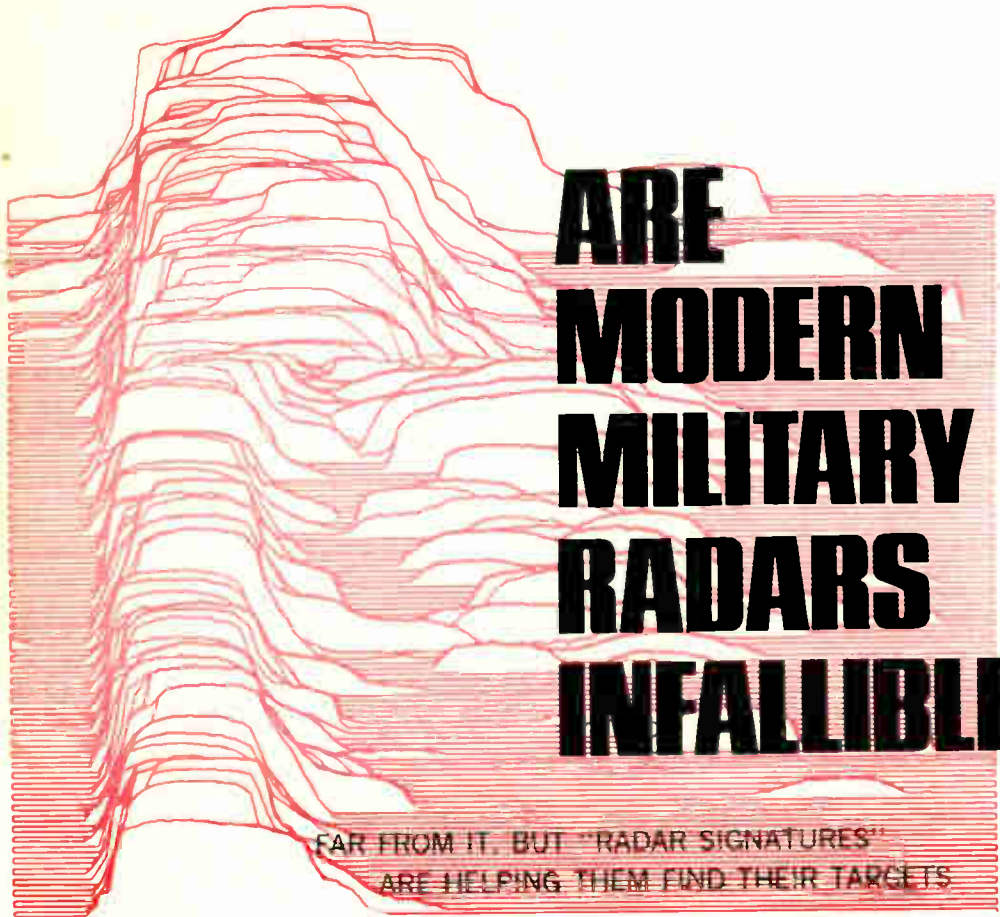

ARE MODERN MILITARY RADARS INFALLIBLE?

FAR FROM IT. BUT "RADAR SIGNATURES"
ARE HELPING THEM FIND THEIR TARGETS

WHEN ASKED what function a radar system performs, the normal response is, "Why, it tells you where something is in relation to the radar antenna—the location being described by an azimuth angle and a range in distance." That's true and in most cases, it is all that one needs to know about a target.

However, as radar technology advances, it has been found that other useful information about the target can be determined—specifically, something about the size and shape of the target. This is important if you want to know whether you are watching a single large bird, a flock of small birds, a small single-engine aircraft, a large jetliner, or, in the extreme, a re-entering missile with a warhead.

During World War II, competent radar operators noticed that, with practice, they could sometimes identify the type of target aircraft merely by observing the behavior of the blips on the screen. There was "something" about the blip action that indicated to the acute observer the difference between a single-engine fighter, a multi-engine bomber, and a lumbering cargo carrier.

That mysterious something is now called "radar signature" or, more popularly, "radar cross section". The characteristics of the target which have an effect on the returned signal and contribute to its cross section are: its length and diameter with respect to the radar frequency; its vertical and horizontal polarization with respect to the signal; its ex-

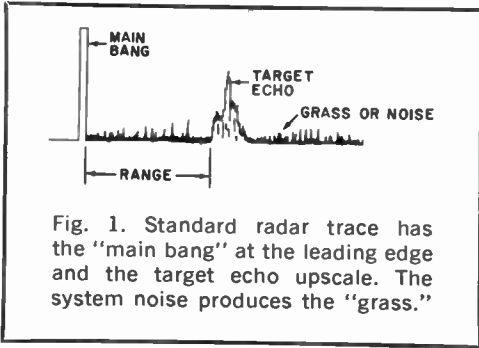

Fig. 1. Standard radar trace has the "main bang" at the leading edge and the target echo upscale. The system noise produces the "grass."

posed area; the material from which it is made (metal produces a stronger return than plastic); its attitude (tumbling, spinning, or proceeding in a straight line); and its wake (ionized, plasma, or none at all). Of course, the characteristics of the transmitted signal also affect the radar cross section (RCS). These include polarization, view angle, and frequency.

The easiest way to visualize what produces a radar cross section is to imagine the radar beam impinging on a metal sphere some distance away. Obviously, no matter how the sphere is oriented, it

always presents the same type of surface to the radar signal and the return echo always has the same configuration when seen on an "A" (scope type) screen, with the "main bang" at one end (start of trace) and the radar return at some distance from the start. If the target has any other shape, then, as it moves relative to the radar beam, the echo varies due to the different surfaces. Thus, if a number of different shapes are used as targets (under controlled conditions), it is possible to identify them by the characteristics of the displayed echo. Similarly, the returns from various types of aircraft can be analyzed so it is possible to determine their external physical characteristics. (Note that the radar cross section can only be used to distinguish external characteristics, which makes the term somewhat of a misnomer, but descriptive nonetheless.)

RCS Techniques. When a radar signal is received, it is usually displayed on an A-type trace and looks somewhat like that shown in Fig. 1. The main bang is the signal representing the transmitter

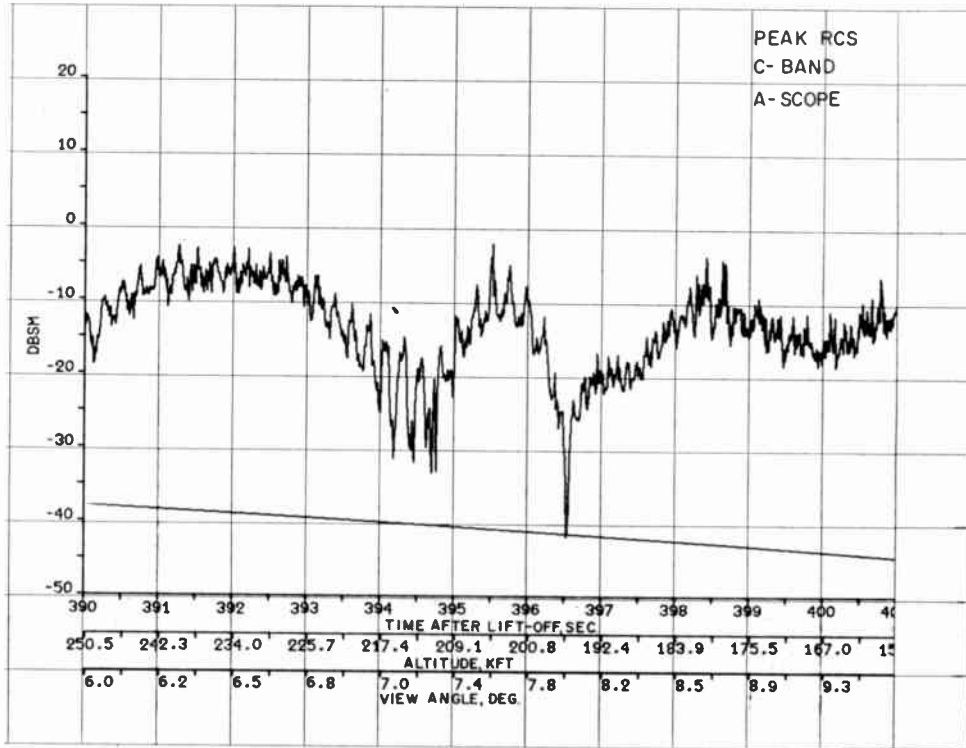
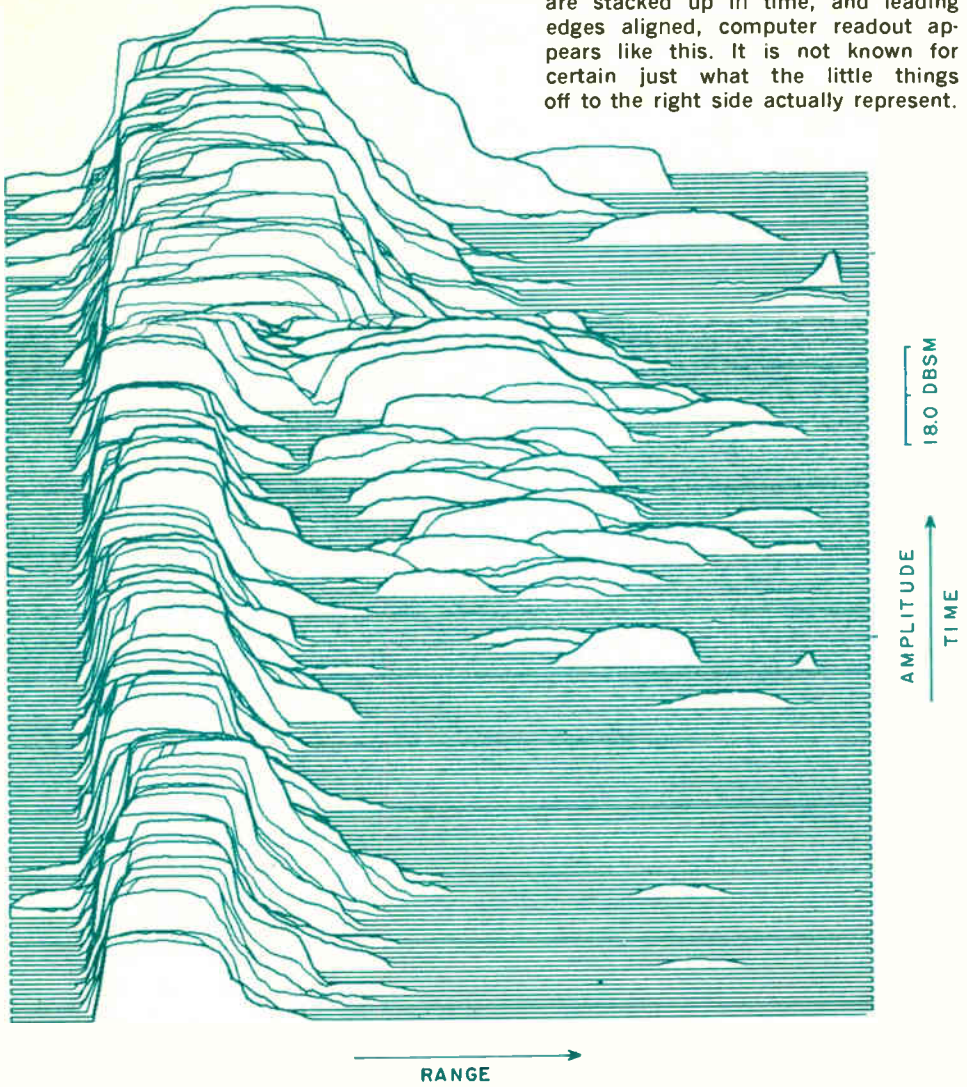

Fig. 2. Typical printout shows variations in target return for time after liftoff, altitude, and view angle. Note peaks at each second, indicating spin, and narrow spike at 396.5.

Fig. 3. When large numbers of traces are stacked up in time, and leading edges aligned, computer readout appears like this. It is not known for certain just what the little things off to the right side actually represent.



pulse. Since the CRT usually has a greenish trace, the system noise which follows is called "grass." The target echo is usually an undulating, complex pulse whose instantaneous shape is a function of the target characteristics mentioned above. Range is calculated from the distance between the main bang and the target pulse, while the azimuth angle is determined by the pointing angle of the antenna with reference to a fixed point, usually north.

At the same time that the signal return is being displayed, it is photographed by fast cameras to record all the individual undulations that make up the complex target pulse. This information is video re-

corded for later playback and detailed analysis by a computer. This is accomplished by a programmable reader that samples pulse amplitudes at equal intervals of the trace with the distance between samples dependent on the sweep speed of the display. During this processing, individual points are automatically converted to equivalent power using special calibration curves, and corrections for off-axis lobe pointing are inserted. After all of this processing, the computer draws—through peripheral equipment—the radar cross section.

Data Interpretation. Radar cross section

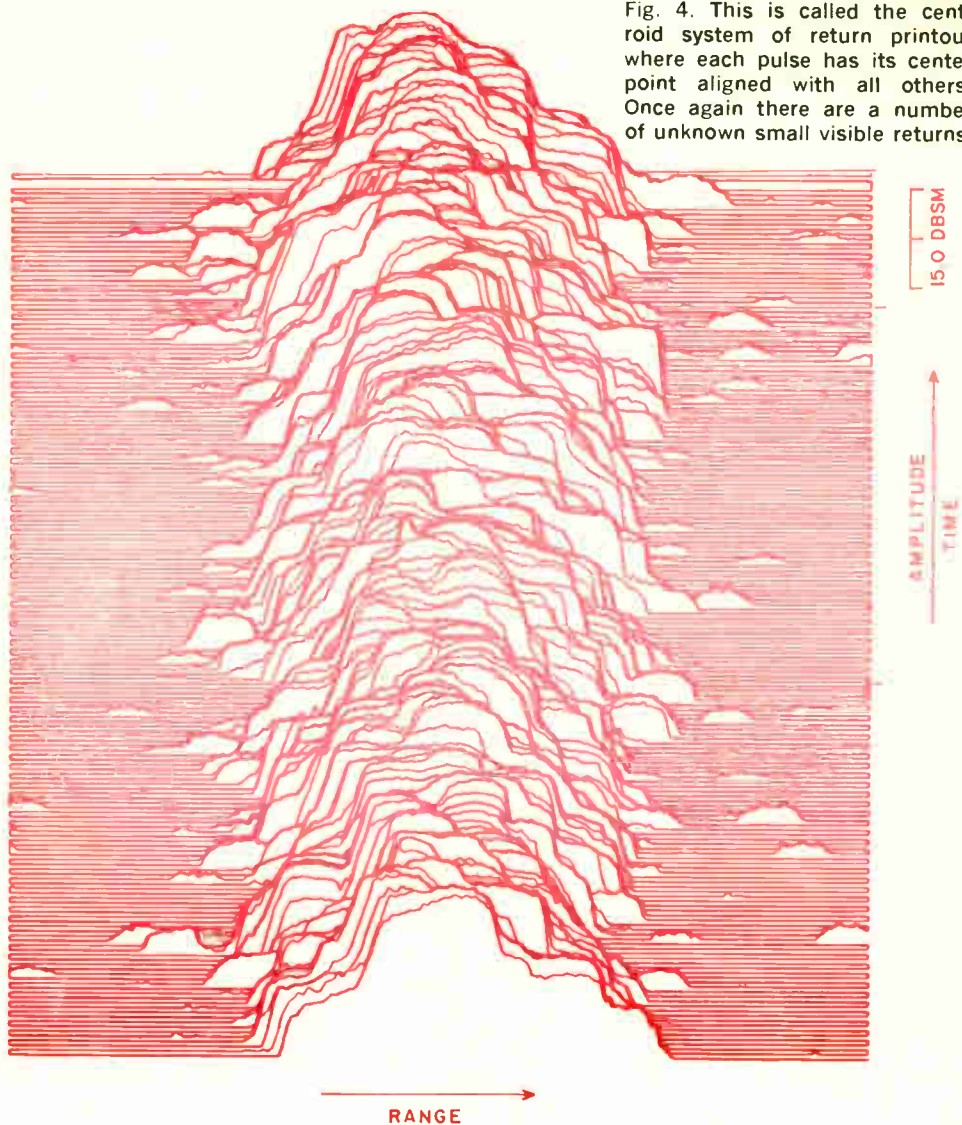

Fig. 4. This is called the centroid system of return printout where each pulse has its center point aligned with all others. Once again there are a number of unknown small visible returns.

is often measured in DBSM (dB per square meter), which is plotted against time, altitude (slant range), and view angle between the antenna and the target. An example of such a plot is shown in Fig. 2. Study of this pattern indicates a long thin vehicle, having one or more protrusions. The vehicle is spinning, thus producing the 5-DBSM peaks at each second. At about 396.5 seconds, its narrowest end (smallest cross section) was presented to the illuminating radar. Note also that the altitude is decreasing with time, indicating a re-entering vehicle from a very high altitude.

New methods of RCS investigation are being developed. Figures 3 and 4 are examples of the latest developments. Figure 3 is a computer readout of data furnished by a radar that employed leading-edge tracking. That is, the radar was locked on to the leading edge of the return pulse. This data was created by programming a computer to draw a picture of each return pulse, starting at the leading edge and aligning all displayed pulses to that edge. Figure 4 was produced by a system using centroid tracking—with the returns synchronized to the center of each pulse rather than the leading edge.

COUNTERMEASURES

Today's military radar—airborne, gun or missile control, or ground interception—relies heavily on the strength of the return signal to identify the size of the target. During World War II, advance strike aircraft dumped massive loads of finely cut aluminum strips (called "chaff") to blind the enemy radar to the following aircraft. As the strips tumbled down, changing their orientation with respect to the radar, random echoes were picked up, usually completely blanking out the prime targets. In some instances, long rolls of aluminum foil (called "rope") were dumped out of the lead aircraft, creating very large unpredictable echoes.

These tactics made it almost impossible for the enemy radar to get an accurate fix on the attack flight. However, both approaches had some serious drawbacks. The lead aircraft was always exposed to the radar; and with the development of range gating, once the foil dropped a reasonable distance below the flight altitude, the attack force could again be picked up on radar. Thus electronic countermeasures were developed—including flying decoys.

Flying decoys—either small aircraft or electronic packages to simulate a missile—are reaching a high degree of sophistication. In their role of deceiving the enemy, decoys use various ways of changing the radar image: reflectors, Luneberg lenses, tuned delay lines,

traveling wave tubes, and active radar. The reflector tends to produce a larger radar return than would be expected from a small flying object. The Luneberg lens is made of layers of dielectric and conducting materials in the shape of a large candy "jawbreaker." The lens is insensitive to the direction of the radar beam, but unfortunately is very sensitive to frequency. Therefore, a lens designed for one frequency is not effective at another.

The purpose of decoys carrying tuned delay lines, travelling wave tubes, or active radar devices is to receive the main bang pulse from an enemy radar, modify its shape to simulate a large aircraft, and fire it back, appropriately delayed in range. Since this type of electronic equipment is small and lightweight, an attack aircraft can carry many decoys so that, when they are released, the real aircraft is lost in the profusion of apparently clean returns.

Another countermeasure approach uses sheer brute signal strength. The attack aircraft carries a powerful transmitter, capable of operating across the known radar bands, which locks on to a received signal and then sends it back to overwhelm the enemy radar.

The advent of satellites and ballistic missiles has sparked an intensive investigation of radar cross sections to permit identifying the intruder long before he can put his countermeasure devices in operation.

Even with these latest approaches to RCS, we still do not have an accurate "photograph" of the vehicle, but it is possible for the trained analyst to visualize the target. As a point of interest, note that, in each of these computer-drawn displays, there appear to be small radar-reflecting objects separated from the main body of pulses. Although it is not absolutely certain, it would appear that these are either an ionized wake (caused by the high velocity through the atmosphere) or fragments breaking off the re-entering body.

Making Measurements. There are two types of radar cross sections: static and dynamic. The former are obtained under carefully controlled laboratory conditions and include full- or partial-scale models in a static (non-changing) environment.

Dynamic measurements involve studies in a free-space environment.

There are a number of static RCS ranges in the United States, operated by various radar manufacturers and universities. The more sophisticated installations are called "ground plane" ranges utilizing the radar energy that travels directly to the supported target, as well as the energy reflected from the earth (Fig. 5A). If the height and elevation of the radar antenna and the height of the target model are properly adjusted, coherent phase addition of the electromagnetic fields occurs. Phase addition can enhance the target returns over the free-space conditions, while suppressing returns from objects near the earth's surface.

At some static measurement ranges, interference from the vicinity of the target

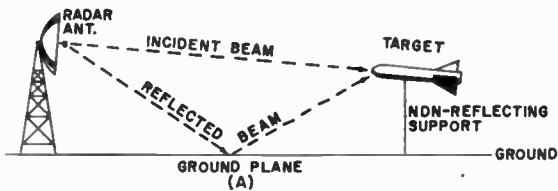
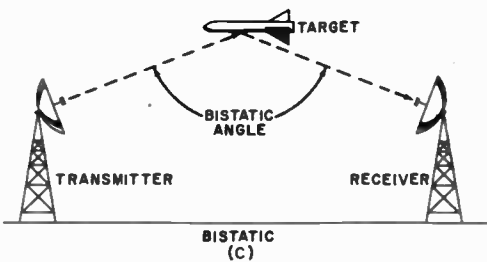
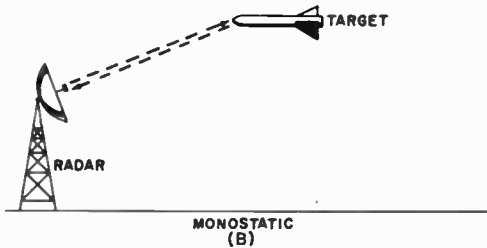

Fig. 5. Three types of commonly used methods of creating radar cross section measurements. The target can be full size or scaled and is suspended on lines that don't reflect the radar.



can be considerably reduced by mounting all metal objects (such as rotators, etc.) below the surface and mounting the reflecting target on non-metallic supports that produce a minimum of reflection at the radar frequency employed. At some ranges, the receivers are range gated so that they accept only signals from a prescribed "block" of space (where the tar-

get is located). This reduces background interference from reflecting targets outside the target area. In some ranges, especially those in the Western desert areas, the radar signatures of insects that accidentally enter the range gate area have been measured.

There are three basic ways to "look" at a radar target: monostatically, bistatically, and multistatically. A monostatic system (Fig. 5B) has its transmitting and receiving antennas at the same location—usually the same antenna. Thus, a transmitted pulse going out to the target is reflected back along the same path to the receiving antenna. In a bistatic system (Fig. 5C), the transmitting and receiving antennas are separated, with the angle between the two beams called the bistatic angle. A radar pulse in this system has a different characteristic from that of a monostatic system.

A multistatic system uses one transmitter and several receivers and usually has such refined approaches as correlation techniques. This produces the effect of looking at an object in "stereo," producing a much more realistic view.

Why use separate antennas just to achieve a different return? If the elemen-

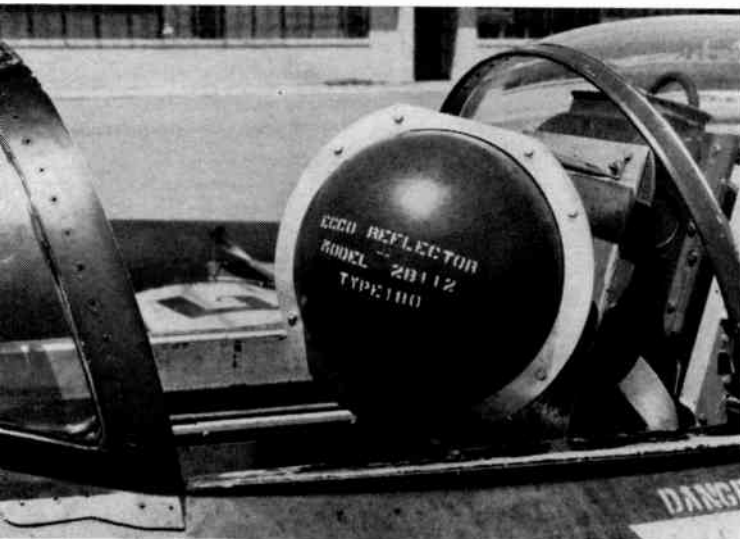

This is a Luneberg lens made from layers of dielectric and conducting material. Although a good radar reflector, it is very frequency selective and is ineffective off frequency.

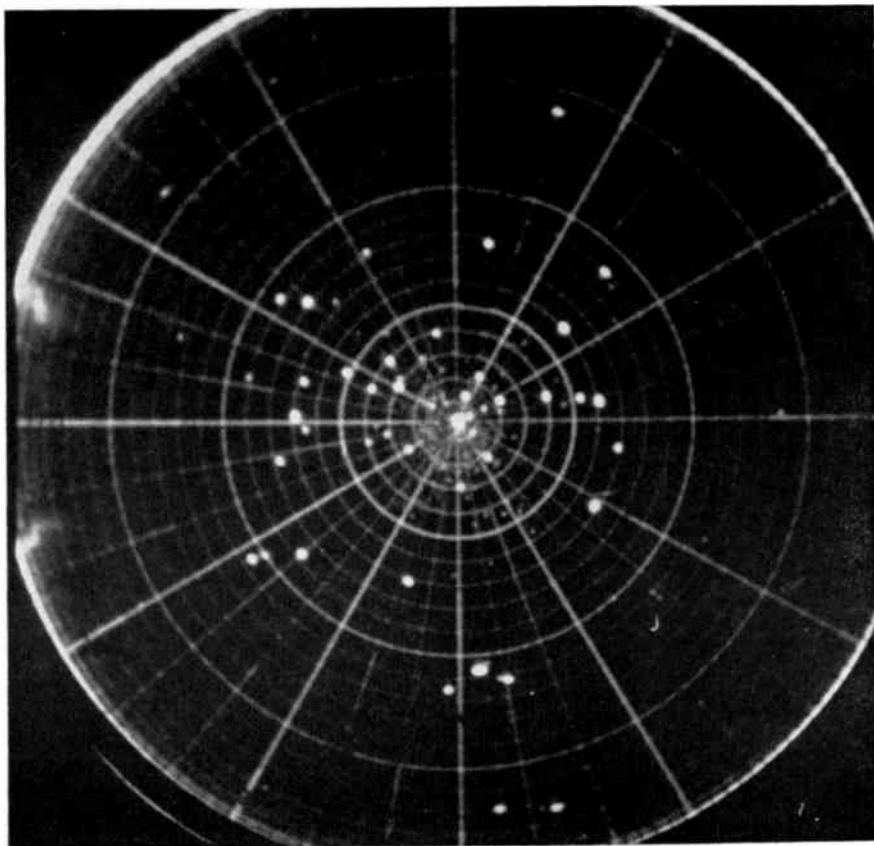

This radar screen can present quite a problem. It is possible that some of the targets are real aircraft, while the others are decoys that just simulate aircraft.

tary theory of corner reflectors is reviewed, you will note that the energy impinging on a corner reflector is returned along the same path to the source (Fig. 6). Thus a monostatic radar shows a

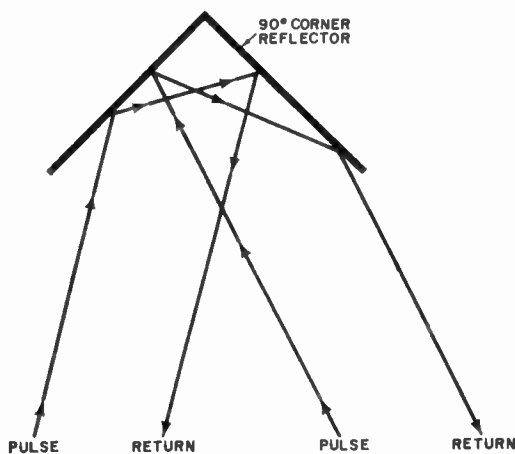

Fig. 6. Theory of the corner reflector that illustrates how this device returns the radar beam along same path on which it came.

greater cross section from a corner reflector than does a bistatic type. This provides a method of discriminating between real missiles and decoys having corner reflectors to enhance their RCS. One of the great advantages of bistatic and multistatic radars is their ability to discriminate.

The Future of RCS. The resolution capability of radar is constantly being upgraded. With the use of synthetic-spectrum radar, chirped radar, phased-array systems, etc., the resolution should improve to the point where the image of a distant target will correspond more to its physical than its electrical features.

The behavior of wake and plasma phenomena is becoming better understood as more advances are made. Coupled with new approaches to computer printout, this should provide displays of greater validity. The entire field of RCS in re-entry physics, radar profiling, passive radar detection, and large-scale air traffic control has barely been opened. ♦

IT'S NOT NECESSARY
TO KNOW ALL THE CIRCUITS
SO LONG AS YOU

UNDERSTAND THE SYSTEM

BY WALTER H. BUCHSBAUM

WHAT MAKES one man "better" at electronics than another? Is it education? Apparently not, since we all know some guy just out of high school who can figure out what's wrong with a complex circuit long before his neighbor who has his BS in EE. Is it work experience? No, again, because there's always the kid fresh from school who can diagnose a fault in a piece of electronic gear while the "old timer" is still studying the schematic. Is it just plain "brightness?" The latter is often used to explain why some people seem to be so much faster in figuring out how things work. But what is brightness? What seems to enable one man to "think faster" than another?

Without going into philosophy or psy-

chology, let's consider the words "concept or systems understanding." This is not a difficult subject because the bright people really use it all the time—often without even knowing it. Systems, or concept, understanding permits one man to take a fast look at a faulty piece of gear and come up with a solution while someone else has to use test instruments and work all day to arrive at the same conclusion. What bugs most of us is that we often feel we know more about basic electronics than the other guy, yet he amazes us with his insight into the problem.

What Is the Function? Take a look at the schematic in Fig. 1. Without reading the

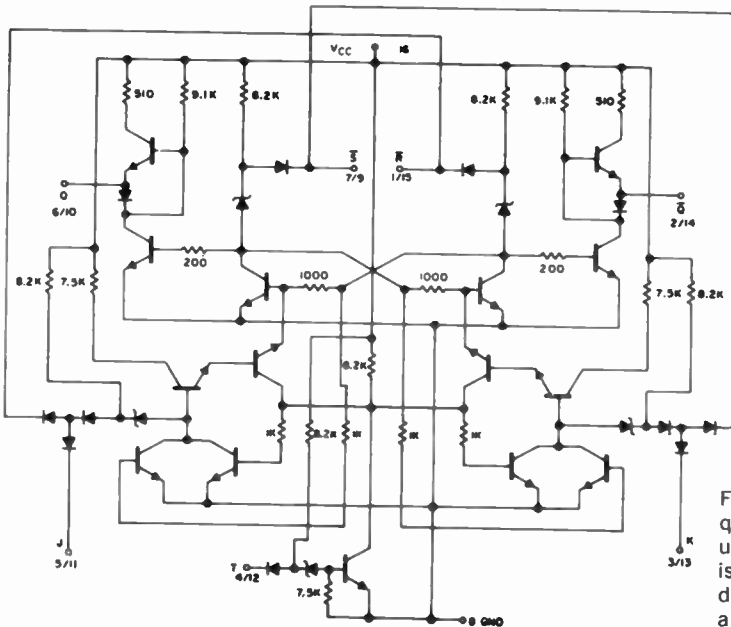

Fig. 1. It might take you quite a few hours to figure out what this circuit is. The clue is in the pin designation letters. It is a JK-RS IC flip-flop.

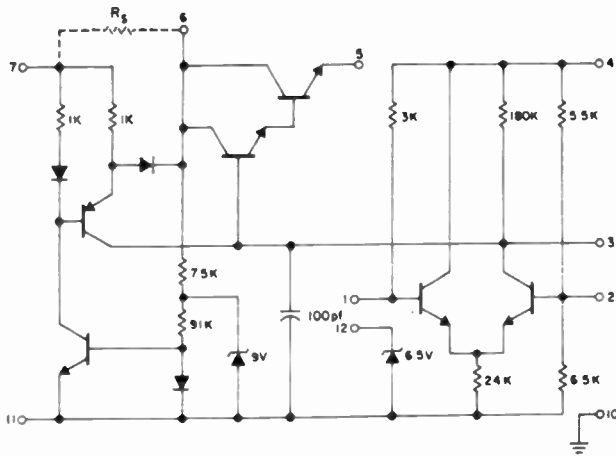

Fig. 2. There are no pin designations to give this circuit a name. Actually it is an IC power supply regulator. Note that both this and Fig. 1 are quite complex and are really a waste of time to try to figure out since the complete operation is shown in the next two figures in a manner far more easy to understand—the system concept.

caption, what is the circuit and how does it work? If that stumps you, try the simpler circuit in Fig. 2. If you have difficulty analyzing these circuits, don't feel too bad. They happen to be integrated circuits, and while you were wasting your time trying to figure them out, all the information you really needed was "function" (what does it do?), "input and output" (what are the signals like?) and "specifications" (how is it tested?). This information is readily available from the

ages are with respect to each other. Isn't that a lot simpler than trying to figure out what every transistor in Fig. 1 is doing at each instant? Consider the time saved.

Now take another look at Fig. 2 and its black box equivalent in Fig. 4. The information in Fig. 4 says: If the input voltage level is correct, the output voltage must be as specified or the IC is defective (discounting the discrete components). Of course, in a system with several black boxes, some other factors enter the pic-

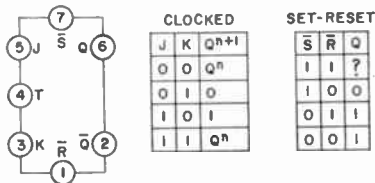

Fig. 3. This is how the flip-flop should be shown. What you see above gives far more information than shown in Fig. 1.

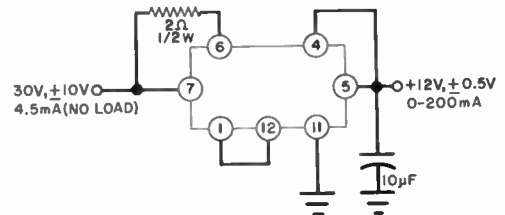

Fig. 4. This is complete story on the power supply regulator shown in Fig. 2. Once again, this gives more information than is contained in complex schematic.

manufacturer's data sheets. You don't have to figure out a thing; it was all done for you long ago by the IC designers.

The entire circuit shown in Fig. 1 can be represented by a "black box" such as that shown in Fig. 3; and this gives you all the information you need to know about that complicated circuit. The information in Fig. 3 says: When certain voltages (0 or 1) are present on the J and K inputs and a toggle pulse is applied, the flip-flop may or may not change states depending on what the J-K or R-S volt-

ture, but the basic idea of the black box equivalent remains valid.

The two examples above show that you do not have to understand the detailed operation of complex circuits to figure out what is wrong when a problem occurs. All you need to understand is the concept—what role each black box plays in the overall scheme. This is what we call concept understanding. It is also called systems science or systems engineering. Whatever it is called, there is (Continued on page 99)

10 Reasons why RCA Home Training is your best investment for a rewarding career in electronics:



Performing transistor experiments
on programmed breadboard—using
oscilloscope

1 LEADER IN ELECTRONICS TRAINING

When you think of electronics, you immediately think of RCA... a name that stands for dependability, integrity, and pioneering scientific advances. For over half a century, RCA Institutes, Inc., a subsidiary of RCA, has been a leader in technical training.

2 RCA AUTOTEXT TEACHES ELECTRONICS FASTER, EASIER, ALMOST AUTOMATICALLY

Beginner or refresher, AUTOTEXT, RCA Institutes' own method of programmed Home Training will help you learn electronics more quickly and with less effort, even if you've had trouble with conventional learning methods in the past.

3 WELL PAID JOBS ARE OPEN TO MEN SKILLED IN ELECTRONICS

RCA Institutes is doing something positive to help men with an interest in electronics to qualify for rewarding jobs in this fascinating field. There are challenging new fields that need electronics technicians... new careers such as computers, automation, television, space electronics where the work is interesting and earnings are greater.

4 WIDE CHOICE OF CAREER PROGRAMS

Start today on the electronics career of your choice. On the attached card is a list of "Career Programs", each of which starts with the amazing AUTOTEXT method of programmed instruction. Look the list over, pick the one best suited to you and check it off on the card.

5 SPECIALIZED ADVANCED TRAINING

For those already working in electronics or with previous training, RCA Institutes offers advanced courses. You can start on a higher level without wasting time on work you already know.

6 PERSONAL SUPERVISION THROUGHOUT

All during your program of home study, your training is supervised by RCA Institutes experts who become personally involved in your efforts and help you over any "roughspots" that may develop.

7 HANDS-ON TRAINING

To give practical application to your studies, a variety of valuable RCA Institutes engineered kits are included in your program. You get over 250 projects and experiments and as many as 22 kits in some programs. Each kit is complete in itself. You never have to take apart one piece to build another. They're yours to keep and use on the job.

8 FCC LICENSE TRAINING—MONEY BACK AGREEMENT

Take RCA's Communications Career program—or enter with advanced standing and prepare immediately for your 1st, 2nd, or 3rd class FCC Radio Telephone License examinations. RCA Institutes money-back agreement assures you of your money back if you fail to pass the FCC examination taken within 6 months after completing the course.

9 CONVENIENT PAYMENT PLANS

You get a selection of low-cost tuition plans. And, we are an eligible insti-

tution under the Federally Insured Student Loan Program.

10 RCA INSTITUTES IS FULLY ACCREDITED

RCA Institutes is an accredited member of the National Home Study Council. Licensed by N. Y. State—courses of study and instructional facilities are approved by the State Education Department.

**VETERANS: TRAIN
UNDER NEW GI BILL**

SEND ATTACHED POSTAGE PAID CARD TODAY! FREE DESCRIPTIVE BOOK YOURS WITHOUT OBLIGATION!

If reply card is detached, send this coupon today.

RCA INSTITUTES, INC.
DEPT. 694-109-0
320 W. 31 ST.
NEW YORK, N. Y. 10001

Please send me FREE illustrated career catalog. I understand that I am under no obligation.

Name _____

Address _____

City _____

State _____ ZIP _____

Age _____

Veterans: Check here

Construction of Multimeter.

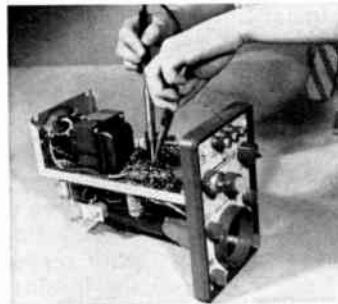

Construction of Oscilloscope.

Temperature experiment with transistors.

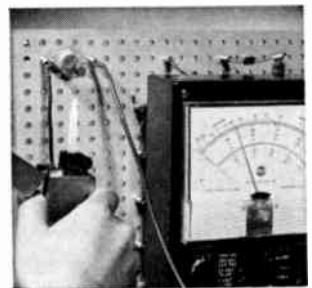

RCA

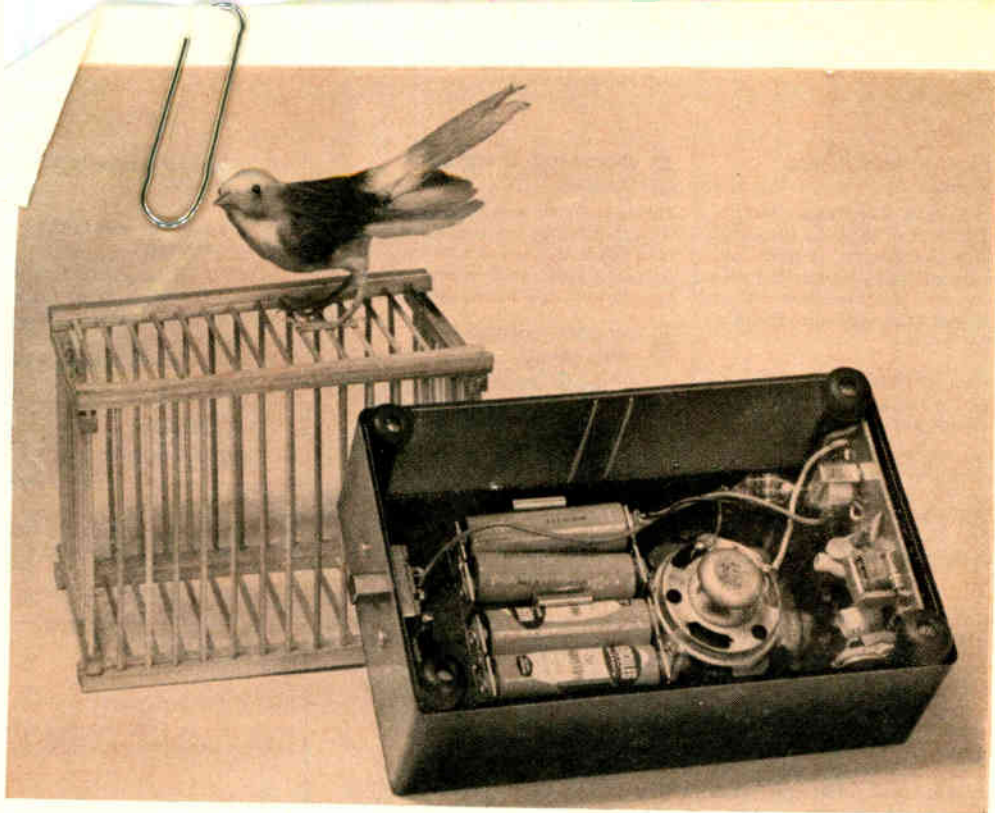

The Solid-State Bird

WHISTLES AND WARBLES LIKE A CANARY

BY JOHN S. SIMONTON, JR.

IF YOU LIKE the sweet, warbling song of a canary but don't dig that cage to be cleaned, try this electronic bird—a real solid-state, battery-operated singer. When turned on, the bird whistles down-scale for a few seconds, breaks into a warble, and, after several seconds, shuts off—only to start again automatically in a few more seconds.

The bird's circuit, shown schematically in Fig. 1, is deceptively simple in appearance. The most immediately obvious feature is an astable multivibrator made up of $Q1$, $Q2$, and their associated base timing circuits. Not so obvious is the blocking oscillator whose principal components are $Q2$, $C2$, and $T2$. The latter produces the warble.

When power is turned on, the bias circuits cause $Q1$ to be turned on and $Q2$ off. Capacitor $C1$ is initially discharged; but, as it begins to charge up through $R3$,

$Q2$ becomes forward biased by the current through $T1$ and $R4$. Eventually, the point is reached where $Q2$ acts as a blocking oscillator, and $Q1$ follows it because of coupling through $C5$.

During this oscillation, $C1$ is charged in a negative direction as a result of the half-wave rectification provided by $Q2$ (which is reverse biased during negative half cycles). Since the charging current is heavy at first and tapers off as $C1$ charges, the inductance of $T1$ goes from a low value to a high one because of the decreasing core saturation. The output tone then decreases in pitch.

Capacitor $C1$ goes rapidly negative with respect to ground, and its effect in the biasing of $Q2$ is replaced by the action of the oscillator itself during the positive half cycles and the charging current through $C4$ during the negative half cycles. Eventually, $C4$ charges to the

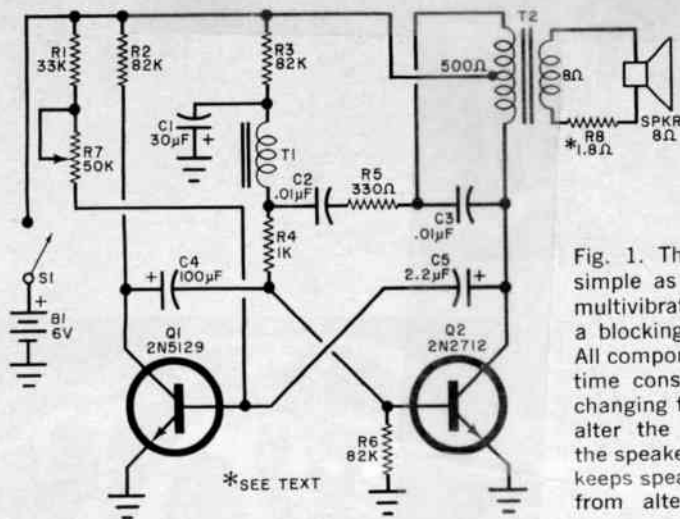

Fig. 1. The circuit is not as simple as it looks. Besides a multivibrator, there is also a blocking oscillator in there. All components are part of one time constant or another, so changing the value of one will alter the final sounds. Note the speaker damping (R8) that keeps speaker acoustic loading from altering the oscillator.

PARTS LIST

B1—6-volt battery (4 AA cells in series)
 C1—30- μ F, 6-volt electrolytic capacitor
 C2, C3—0.01- μ F disc capacitor
 C4—100- μ F, 6-volt electrolytic capacitor
 C5—2.2- μ F, 6-volt electrolytic capacitor
 Q1—2N5129 transistor
 Q2—2N2712 transistor
 R1—33,000-ohm, $\frac{1}{2}$ -watt resistor
 R2, R3, R6—82,000-ohm, $\frac{1}{2}$ -watt resistor
 R4—1000-ohm, $\frac{1}{2}$ -watt resistor
 R5—330-ohm, $\frac{1}{2}$ -watt resistor
 R7—50,000-ohm trimmer PC potentiometer

R8—1.8-ohm, $\frac{1}{2}$ -watt resistor
 S1—Spst slide or toggle switch
 T1—10K:2K driver transformer (Lafayette TR-98, 99F61269 or similar)
 T2—500-ohm CT:8-ohm output transformer (Lafayette TR-116, 99F61293 or similar)
 Misc.—8-ohm speaker, plastic case, battery clips, wire solder, etc.

Note—The following are available from PAIA Electronics, PO Box 14359, Oklahoma City, OK 73114: etched and drilled PC board, \$1.25; complete kit less batteries and case, \$5.95; both postpaid in USA.

point where its contribution to the Q2 biasing is small and the base/emitter junction of Q2 is reverse biased during a larger portion of each succeeding cycle. At some point, the blocking oscillator starts to "squegg." That is, the charge ac-

cumulated on C2 during negative half cycles is large enough that Q2 is turned off completely until the charge leaks off. Once the charge has leaked off, Q2 can oscillate once more. This charge-discharge cycle happens so rapidly that the audio

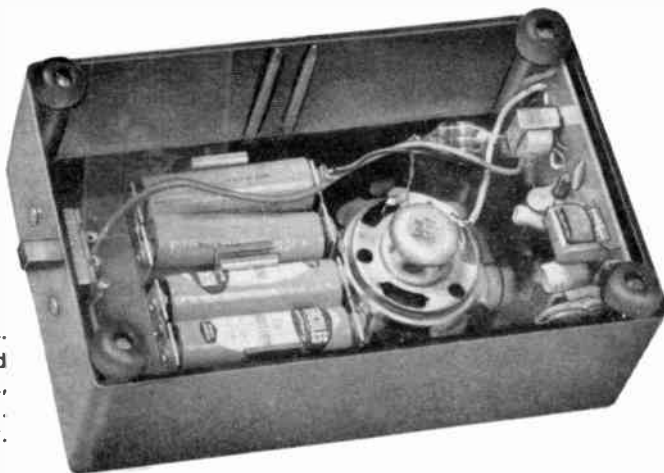

In prototype mounting arrangement, the speaker is mounted at the "bottom" of the box, while the "top" is left open. The rubber feet fit in cover.

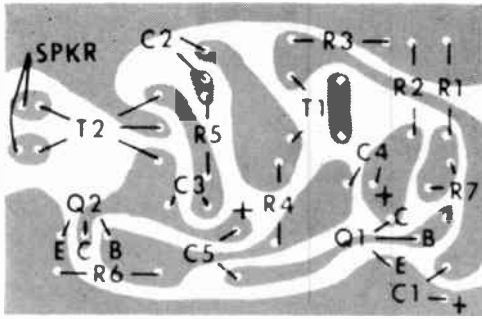
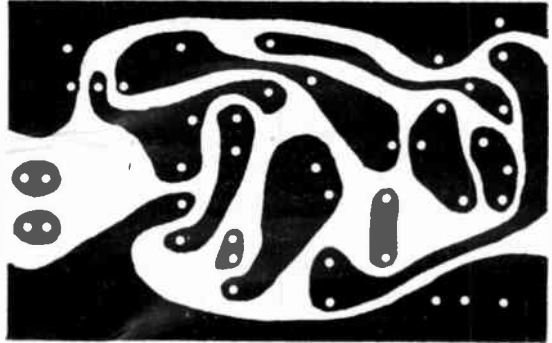

Fig. 2. Actual size foil pattern (right) and component installation (above). Note that miniature transformers must be used on this small PC board. It has been laid out so that it just fits in 6" x 3" x 2" plastic utility box.



tone generated sounds like a warbling bird. Finally, C4 discharges to the point where it makes no contribution to the biasing of Q2 and the latter turns off. With Q2 off, Q1 turns on and the cycle repeats.

Construction. Layout of the bird is not critical and any method of construction may be used. If you want to use a printed circuit board, the foil pattern and layout in Fig. 2 can be used. During assembly, be sure to observe the polarities of capacitors and semiconductors and do not overheat the components when soldering.

Component values are important. The circuit will work with the normal 10% tolerance of resistors and 20% tolerance of capacitors, but variations of any larger degree will throw it off. Every component determines some type of time constant, so if you change the value of one component, be prepared to change the rest.

Install leads on the board for the speaker and battery, making them long enough to reach when the board is located in the selected cabinet.

Since the output stage (Q2) works di-

rectly into the speaker without any buffering, any change in the speaker loading will be reflected back into the oscillator circuit, resulting in a change in the sound. This means that the selected enclosure (for board, batteries, and speaker) must have no resonant or antiresonant peaks. Resistor R8 is included as an option to isolate (partially) the speaker from the circuit.

The prototype was built in a conventional 6" X 3½" X 2" plastic case with the front cover not used. In the bottom of the case a hole was cut for the speaker. Make the hole slightly smaller than the diameter of the speaker and cement the speaker to the case behind the hole. Four rubber feet were attached to the holes on the opposite side (where the front panel was). The battery clips were mounted on the same side as the speaker with the PC board cemented to one wall and the power switch on the other wall.

The plastic case should be dressed up with a toy bird to complete the illusion. There are many garden supply houses that stock colorful stuffed birds—some even have small wood or metal cages to enclose the bird. ♦

The Operational Amplifier

What it is & How it works

BASIC APPLICATIONS FOR THIS VERY VERSATILE IC DEVICE

IN THE FIRST PART of this article, we discussed the "perfect amplifier" and its characteristics. However, there is no such thing as a perfect amplifier and we must work with things that exist in the real world. So, how about applications for the real operational amplifier? Figure 1 shows the characteristics of one typical low-cost op amp (Texas Instruments SN72709N), which is a member of the famous 709 family.

This device has an open loop gain of 50,000, an input resistance of 250,000 ohms, an open loop output impedance of

150 ohms, and one microampere input offset current with two millivolts offset voltage at the output. These are typical specifications for most 709 op amps, regardless of manufacturer.

The best way to experiment with an integrated circuit of any kind without damaging it in soldering and desoldering is to make up a breadboard similar to that shown in Fig. 2. Suitable solder terminals are mounted on a piece of plastic and the IC is attached to the board with adhesive with its leads up. Each pin of the IC is then connected to one of the ter-

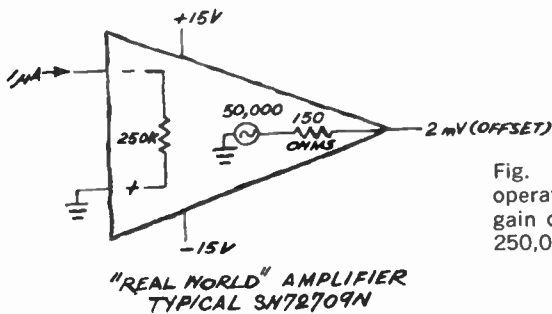

Fig. 1. Characteristics of a typical operational amplifier. This one has a gain of 50,000, an input impedance of 250,000 ohms, and a 150-ohm output.

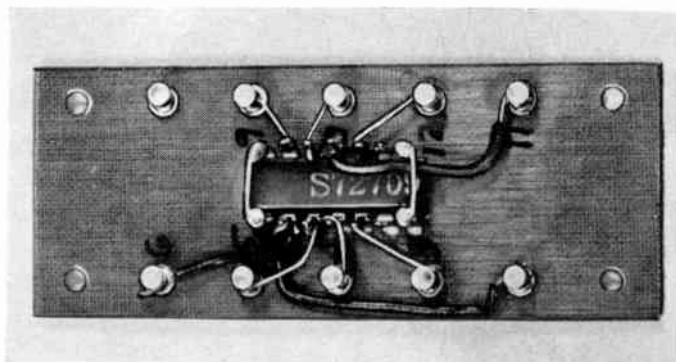

Fig. 2. This simple breadboard approach may be used to connect up an op amp. The layout below shows a circuit fully wired.

minals. Each terminal is identified as to pin number or function, and all external components and circuits are hooked up to the appropriate terminals.

Another approach is shown in Fig. 3. Here, a 14-pin dual in-line socket is mounted on a board, with a suitable number of terminals around the edge. The circuit can then be built up between

the socket leads and the perimeter terminals. Figure 3 also shows how a round TO-99 case can be inserted in the socket, with the pins properly mated.

Typical Applications. Although only a few circuits will be described here, they are basic to all of the many variations that are found in this and other publica-

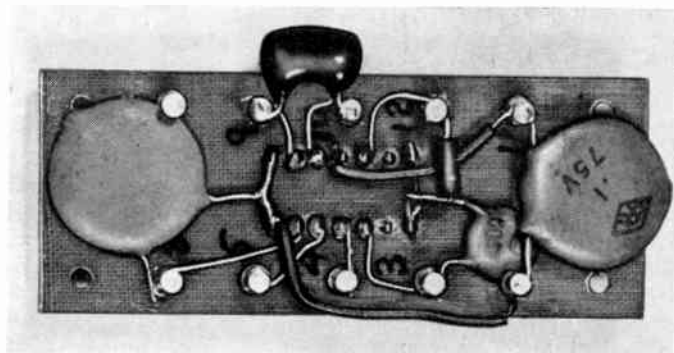
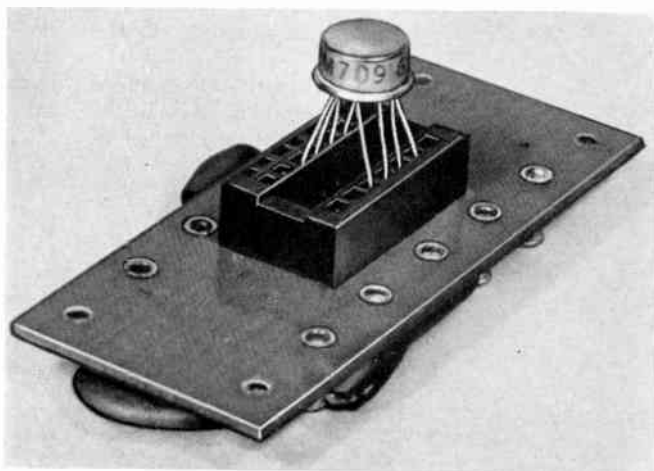

Fig. 3. If you mount a dual-in-line socket on the breadboard, it can be used for both in-line and round IC's.



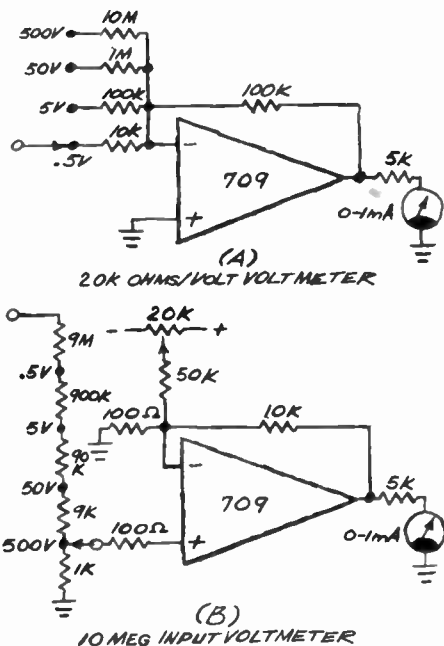

Fig. 4. A pair of dc voltmeters using an op amp. The circuit at (A) is 20,000 ohms per volt, while that at (B) is 10 megohms per volt. Text discusses design changes to improve this simple design. In both cases, the meter has a conventional 0-1-mA movement.

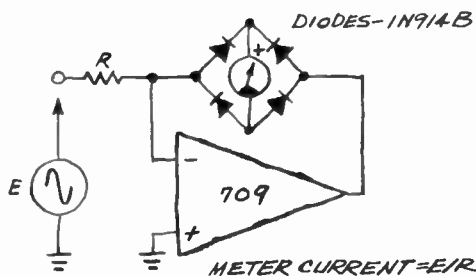

Fig. 5. Typical ac voltmeter basic circuit using an op amp. Although the input impedance is only 1000 ohms per volt, by adding an op amp buffer in front, impedance can be raised.

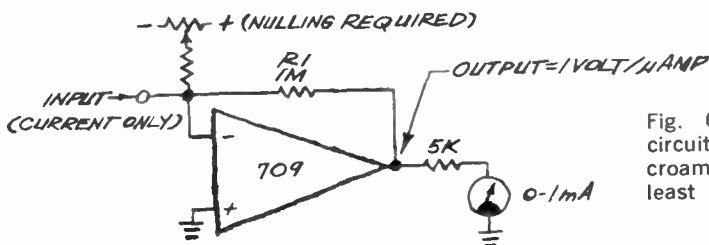

Fig. 6. This current-to-voltage circuit indicates 1 volt per microampere and is capable of at least .1-microampere sensitivity.

tions. Note that, although some of the circuits shown here do not have compensation, it is always necessary to compensate a 709. This is not true, however, of some other op amps so the specifications should always be checked.

The two dc voltmeters shown in Fig. 4 illustrate some interesting points. In both circuits, the 5000-ohm output resistors can be changed to affect the basic circuit sensitivity. For example, making this resistor 1000 ohms gives both voltmeters full-scale ranges from 0.1 to 100 volts. Circuit A would then have an input sensitivity of 100,000 ohms per volt, but circuit B would retain its original 10-megohm input. Circuit B also has a null balance circuit since the typical offset of a 709, multiplied by the gain of 100, would produce a significant zero offset on the meter. In this case, with the input shorted, the null offset potentiometer is adjusted to obtain a zero on the meter. Such a voltmeter would be ideal not only for solid-state testing (since it has the necessary low-voltage scale), but also for vacuum-tube circuits where the dc voltage could reach 500.

A very linear ac voltmeter is shown in Fig. 5. In this circuit, diode nonlinearity is minimized by the high gain of the amplifier. Sensitivity is the same as that of the meter: that is, 1000 ohms per volt for a 1mA meter. A higher input impedance can be attained by using an op amp buffer in front of this circuit.

The current-to-voltage transducer shown in Fig. 6 makes use of the current sensitivity of the op amp to measure very small currents. As shown, the circuit indicates 1 volt per microampere and is capable of 0.1-microampere sensitivity. Resistance values for R_1 can be between 100,000 and 10,000,000 ohms to provide outputs from 10 μ A per volt to 0.1 μ A per volt.

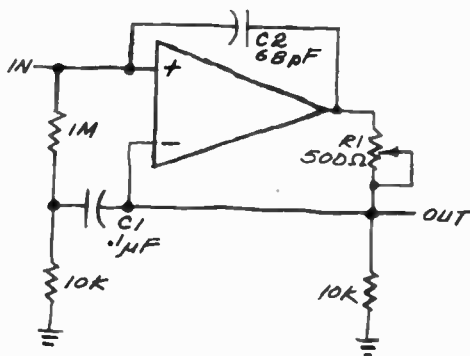

Fig. 7. This circuit, developed by NASA, has an input impedance of several hundred megohms with an input capacitance of less than 1 pF.

The circuit shown in Fig. 7 is an example of just how far you can go in creating an ultra-high input impedance with an op amp. Developed by NASA, the circuit has an input impedance of several hundred megohms with an input capacitance of less than 1 picofarad. The high impedance is obtained by positive feedback through C1. The input capacitance plus the capacitance to ground can be cancelled by adding feedback capacitor C2 and properly adjusting R1.

The low-frequency response is determined primarily by C1, for which an electrolytic capacitor may be used. High-frequency response is limited by the op amp. With a square wave applied to the input, potentiometer R1 is adjusted to obtain a square wave on the output (similar to making a scope attenuator adjustment). The circuit was designed to amplify a 5- μ s pulse coupled through a 1-pF capacitor. The slew rate is approximately 0.5 volt per microsecond.

Two gain-control, or variable-attenuator, stages are shown in Fig. 8. Note that two different input resistances are shown—one very high, the other low—and that the gain of either stage can be varied by changing the feedback circuit. A word of caution: when the feedback potentiometers are at their minimums, the effective load on the amplifier is 5000 ohms. Be sure that the feedback resistors do not "use up" all the available output current.

An interesting use of the op amp is in frequency-selective networks. With conventional discrete semiconductor circuits, it is usually necessary to use large induc-

tors to perform this operation at low audio frequencies. In the circuit shown in Fig. 9, a twin-T filter (which has a resonance similar to its LC counterpart), is used in the feedback circuit. Figure 9 shows the method of calculating the element values for any frequency. Unfortunately, the Q of a twin-T filter is rather small—on the order of 0.25; but, when combined with the gain of the op amp, the Q is a reasonable value. Using an amplifier with a gain of 10, the Q is 2.5; and with a gain of 40, the Q is 10. Thus an op amp, with a few passive components, can be used to simulate a bulky, expensive inductor; and it has the advantages of a center frequency and Q that are easily controlled over a wide frequency range.

Another audio filter, this one generating a notch at the selected frequency and having a variable Q, is shown in Fig. 10. The input to the positive terminal of the op amp is combined with feedback through the bridge-T network. The other input is variable. When the signal levels at both inputs are equal, there is no output from the amplifier. System gain is still R2/R1. By adjusting the "SET" control, a small notch at the filter frequency is obtained. As the "Q ADJUST" control is brought near the filter end, the feedback increases, controlling the Q of the circuit. The frequency is determined by the values of the filter capacitors and the setting of the ganged potentiometers.

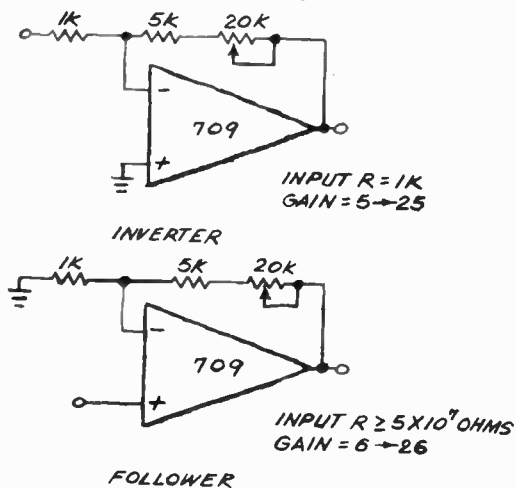
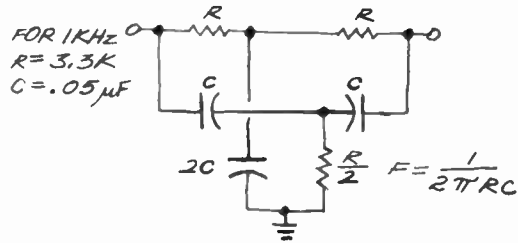
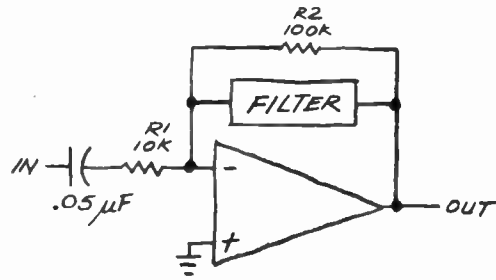

Fig. 8. A pair of variable attenuator circuits. The upper one has an input resistance of 1000 ohms, while the bottom circuit has a 50-megohm input. Gain is very similar.

Fig. 9. A frequency selective network in the feedback loop of an op amp can simulate an LC circuit having a high Q at audio frequencies. Both Q and center frequency can easily be changed by varying the RC values.



Performance Limitations. Input limitations are applicable primarily to follower configurations, provided, of course, that input overloads are avoided. The summing junction of an inverter remains at ground except when fast voltage spikes or extremely high voltages are applied. In the first case, feedback is too slow to protect the summing junction; while in the second case, the output stage saturates and is unable to divert the input current. In followers, the summing junction moves in step with the input voltage so that, in some circuits, the input must be restricted to 15 volts. In Fig. 4B, for example, the divider restricts the summing junction excursions until the output stage saturates. The amplifier has a gain of 100 (101 if the resistor values are exact), and an input in excess of 0.1 volt would saturate the amplifier at an output over 10 volts. If a 10-volt input were allowed, the summing junction would be

driven so high that the input transistors in the op amp would probably be destroyed.

Performance limitations having to do with offset voltage and current are largely inconvenience factors. External null circuits balance out offsets over a small range of ambient temperatures. Offset effects (as well as open loop gain and input resistance) vary with ambient temperature, so circuits that must operate in changing temperatures should be designed around amplifiers with low offset. Op amp circuits with low values of R_1 and R_2 are not bothered by offset currents, while circuits with low closed loop gain suffer little from offset voltage. For special applications, where extreme accuracy and/or stability is needed, it is important to consider not only the open loop characteristics of the amplifier, but also the accuracy and temperature stability of the external components.

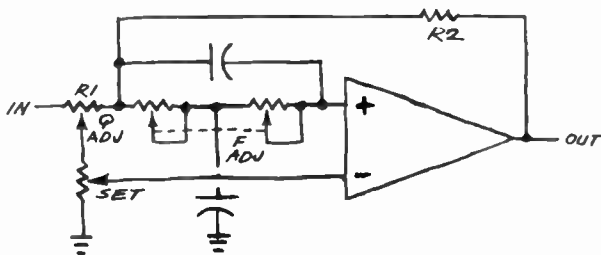

Fig. 10. This audio filter permits changing both Q and center frequency via pair of controls.

FAIRCHILD LINEAR INTEGRATED CIRCUITS μ A748

ELECTRICAL CHARACTERISTICS ($V_s = \pm 15$ V, $T_A = 25^\circ\text{C}$ unless otherwise specified)

PARAMETERS	CONDITIONS	709			UNITS
		MIN.	TYP.	MAX.	
Input Offset Voltage	$R_s \leq 10$ k Ω		1.0	<u>5.0</u>	mV
Input Offset Current			20	<u>200</u>	nA
Input Bias Current			80	<u>500</u>	nA
Input Resistance		<u>0.3</u>	2.0	<u>.05</u>	M Ω
Input Capacitance			1.4		pF
Large-Signal Voltage Gain	$R_L \geq 2$ k Ω , $V_{out} = \pm 10$ V	<u>50,000</u>	200,000	<u>12,000</u>	
Output Resistance			75	<u>150</u>	Ω
Output Short-Circuit Current			25		mA
Power Consumption			50	85	mW
Transient Response (unity gain)	$V_{in} = 20$ mV, $C_C = 30$ pF, $R_L = 2$ k Ω , $C_L \leq 100$ pF				
Risetime			0.3		μ s
Overshoot			5.0	<u>10</u>	%
Slew Rate	$R_L \geq 2$ k Ω		0.5		V/ μ s

GENERAL DESCRIPTION — The μ A748 is a high performance monolithic operational amplifier constructed on a single silicon chip, using the Fairchild Planar[®] epitaxial process. It is intended for a wide range of analog applications where tailoring of frequency characteristics is desirable. High common mode voltage range and absence of "latch-up" make the μ A748 ideal for use as a voltage follower. The high gain and wide range of operating voltages provide superior performance in integrator, summing amplifier, and general feedback applications. The μ A748 is short-circuit protected and has the same pin configuration as the popular μ A741 operational amplifier. Unity gain frequency compensation is achieved by means of a single 30 pF capacitor.

ABSOLUTE MAXIMUM RATINGS

	709	
Supply Voltage	<u>± 18 V</u>	± 22 V
Internal Power Dissipation (Note 1)		500 mW
Differential Input Voltage	<u>± 5 V</u>	± 30 V
Input Voltage (Note 2)	<u>± 10 V</u>	± 15 V
Storage Temperature Range		-65°C to $+150^\circ\text{C}$
Operating Temperature Range		-55°C to $+125^\circ\text{C}$
Lead Temperature (Soldering, 60 seconds)		300 $^\circ\text{C}$
Output Short-Circuit Duration (Note 3)	<u>5 sec.</u>	Indefinite

NOTES:

- (1) Rating applies for case temperatures to 125 $^\circ\text{C}$, derates linearly at 6.5 mW/ $^\circ\text{C}$ for ambient temperatures above +75 $^\circ\text{C}$.
- (2) For supply voltages less than ± 15 V, the absolute maximum input voltage is equal to the supply voltage.
- (3) Short circuit may be to ground or either supply. Rating applies to +125 $^\circ\text{C}$ case temperature or +75 $^\circ\text{C}$ ambient temperature.

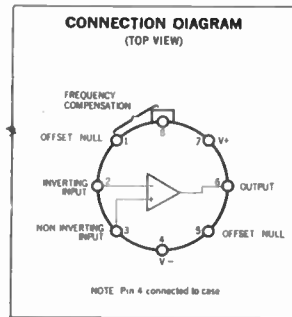
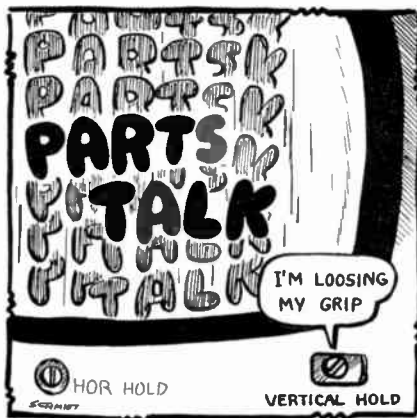

Fig. 11. This is a portion of the specifications sheet on the 748 op amp with the "worst case" parameters underlined. The specs of a typical 709 have been added for comparison purposes.

In choosing an amplifier for a given application, the manufacturer's specification sheets should always be consulted. Unfortunately, these sheets often contain an amazing amount of information—which may be confusing to the uninitiated. Figure 11, for instance, shows part of the information given on the Fairchild μ A748 op amp. Note the two columns headed "709" which have been added to the illustration for comparison purposes. Some of the performance figures have been underlined. These are "worst case" conditions and should be used in circuit design. Also note that some specifications are accompanied by "conditions" (such as a specified load resistor). When comparing amplifiers, these conditions must always be identical. All specifications are always for the open loop configuration unless otherwise noted on the sheets.

By now, you should have a pretty good

idea what an operational amplifier is and how it is used. The next step is to keep your eyes open as you review the technical literature and be aware of the wide variety of op amp circuits available. Then put them to good use. \diamond



Testing Power Supplies

SIMPLE CIRCUIT
IS HIGHLY ACCURATE

BY JAMES N. DEMAS

AT ONE TIME or another it becomes important to be able to check the line and load regulation of low-voltage power supplies. Besides being of intrinsic interest, such data are highly practical. Many circuits are fussy about their power requirements, and poor performance or blown components may result if power regulation is off.

For supplies of modest performance (0.1 to 2% regulation), checking the output can get to be a bit sticky. Multimeters do not have the necessary resolution; and better meters are usually too expensive. Consequently, performance is rarely verified; the experimenter just

crosses his fingers and suffers the consequences if something goes wrong.

Fortunately, a neat, inexpensive solution to this problem exists for supplies delivering five or more volts. All you need is a suitable battery, a potentiometer, a fixed resistor, and a high-input impedance TVM or VTVM with a low dc voltage full-scale readout.

How It Works. The circuit (shown in Fig. 1) can be breadboarded quite easily in a few minutes. Potentiometer $R1$ and resistor $R2$ are in series across the battery, $B1$. Thus, depending on the setting of $R1$, a wide range of dc voltage is possible between the rotor of $R1$ and the negative battery terminal. The voltage of the battery should be slightly higher than that of the supply being measured. Resolution is improved if $R1$ is a multi-turn potentiometer.

The voltage from the battery (E_{ref}) and the supply to be tested (E_u) are connected as shown. A voltmeter connected between points A and B indicates the difference between the two voltages. The difference can be nulled by adjusting the reference voltage. As long as the reference is stable, any changes in E_u (result-

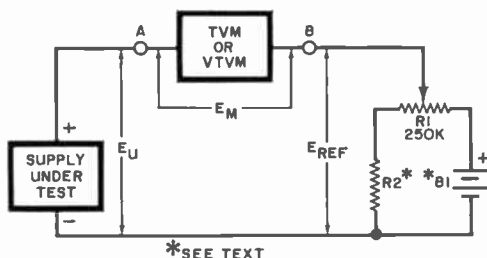

Fig. 1. Reference voltage bucks out tested voltage until the voltmeter indicates zero.

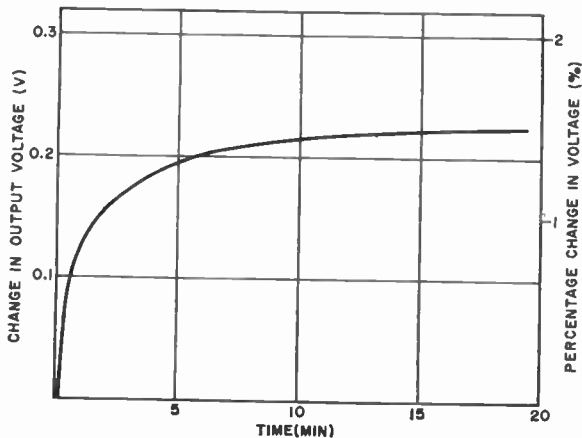

Fig. 2. A typical chart of variation of the output of a homemade power supply over 20-min period.

ing from warm-up drift, line or load variations, etc.) appear as meter indications. For example, if E_u is 10 volts and the voltmeter is set to its 0.3-volt range, a deflection to 0.1 volt would mean a 1% change in E_u . A change of 0.01 volt, which is easily read, corresponds to a 0.1% change in E_u . Thus, even a well regulated supply can be checked.

Comments on Use. The voltage of $B1$ must be high enough for E_{ret} to equal E_u . Because of the low current drain, ordinary 9-volt transistor radio batteries may be used: one for supplies of 5 to 9 volts, two for 8 to 18 volts, and 3 for 17 to 27 volts. Resistor $R2$ should be about 175,000 ohms for one or two batteries; 350,000 ohms for 3 batteries. Even low-cost batteries have a stability better than 0.05% over a period of one hour.

Keep in mind that the voltmeter may drift with time. To zero the meter, remove one lead from the test circuit and short it to the other. Do not short the meter while it is in the circuit. As $B1$ ages, it will become too unstable for meaningful data to be obtained. If drift is noted when a new battery is put in, then you can be sure that a new one was needed.

Allow the reference supply to warm up for about 15 minutes; then adjust $R1$ to obtain a null on the meter when E_u is turned on. When the zero is obtained, call it time zero. Note the meter indications at appropriate time intervals (every five minutes, for example) and record them. The percent regulation is (E_m/E_u)

$\times 100\%$. A chart of variations will look somewhat like that shown in Fig. 2.

Output regulation as a function of load can also be plotted as shown in Fig. 3. In both of these examples, the supply was a homemade low-cost 15-volt circuit. Line regulation can also be checked by using a Variac or similar voltage-variable source in the input. In this case, a 10% change in line voltage produced a regulation of 0.45% (67 mV). This shows that accurate measurements can be made, even with supply changes under 1%. \diamond

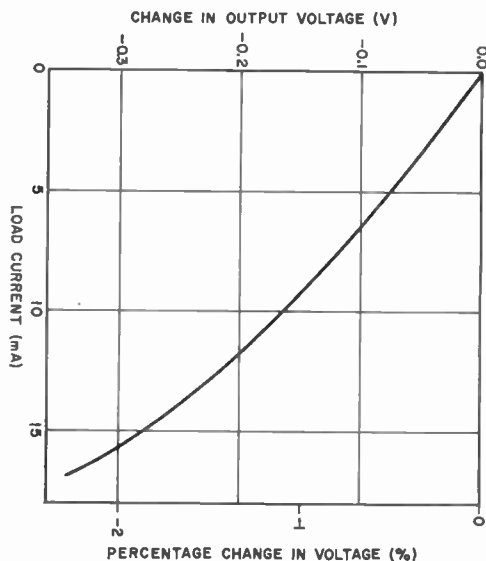

Fig. 3. Output regulation as a function of load current can be plotted as shown here.



COMMUNICATIONS

By Leslie Solomon, Technical Editor

BALLOON ASCENSION

Remember the old gag about using a skyhook to support an antenna? Well, don't laugh any more because the Air Force is studying the possible use of a special free (unmanned) balloon to do just that. It is hoped to keep the balloon, carrying either a battery powered data link or an antenna, on station by various means of ballasting and also by using a propulsion and auto pilot system. Ground radio signals would be used to maintain the desired position, regardless of wind conditions.

The Air Force Cambridge Research Laboratories are seeking prospective contractors. AFCRL has the primary responsibility for Air Force balloon research and development, and launches about 140 instrumental balloons each year. In 1969, one launch involved the world's largest balloon (34 million cubic feet) carrying the heaviest balloon payload of 13,800 pounds. Another of their balloons soared to a record altitude of 161,000 feet. The launch sites for these balloons are in New Mexico and California.

FLASHES FOR THE SWL'S

Effective August 1, Deutsche Welle, the Voice of Germany, will have a relay station operating in Canada. (By the time you read this it should be on the air.) The transmitters are 250 kW and are located in Sackville, N.B. The antennas are beamed to San Francisco and the tentative frequencies are 11.945 and 15.190 MHz. This will be an off-the-air relay from Germany.

Radio Mexico is now putting out 1 megawatt on 9.705, 11.770, 17.835, and 21.705 MHz. They really mean to be heard around.

Incidentally, have you heard Radio Vatican lately? In keeping with the recent liberalization of the Catholic Church, they are starting to broadcast pop music. Quite a change from past years.

MORE CB CHANNELS?

Representatives of the Citizens Radio Section of the Electronic Industries Association's Communications and Industrial Electronics Division recently made a presentation to the FCC emphasizing the inadequacy of the present 27-MHz CB band. These representatives presented a petition for a new class E Personal Radio Service. The petition calls for a segment of 80 channels between 220 and 222 MHz, FM mode, with 25-kHz spacing and a power output limitation of 25 watts.

The FCC has also been encouraged to continue to improve the present class D service through stronger enforcement of existing regulations since that service is now providing essential, though restricted, communications capability to millions of Americans for emergency and necessary personal and business applications on the highways, in recreational vehicles, and commercial areas.

There has been a lot of flack in other magazines, pro and con, on

this petition. My feeling is that there is a definite need for short-haul, reasonably clear channels. The bulk of CB (business, etc.) is not long-distance; and at 220 MHz, the range is limited. There will be no interfering chatter from DX stations to disturb the business at hand. Of course, the hams are going to object to this invasion of their 220-225 MHz band; but this is a legal problem that the FCC and interested ham parties will have to fight out.



Video voice, a new system announced by RCA Global Communications, Inc., permits virtually instantaneous video views by a series of monochrome still pictures transmitted over the same telephone link as used for normal voice communications. Shown here is Howard R. Hawkins, president of RCA Global Communications observing his own monitored image and also that of Motoichi Masuda, managing director of KDD Co., Inc., in Japan. This was first video link between New York and Tokyo.

LATEST REACT REPORT

From July 1970 through March 1971, a total of 4513 emergency calls and requests for assistance from motorists were handled by volunteers participating in the Ohio REACT Emergency Network. A total of 1388 calls were auto accidents. These calls were from motorists equipped with CB gear, which was used to call the REACT group. Non-involved motorists reported almost 50% of the accidents, while directly involved motorists reported 5.6%. REACT members reported 23.5%; 7.9% were from other sources; and 13.3% were not identified as to origin.

If more states had REACT teams and if more CB'ers got involved, this would become an even more important public service—and the build-up would continue to take the "edge" off of the illwill caused by the many clowns who clutter up the bands.

GOOD EVENING, MR. PHELPS

Up to a few weeks ago, a pirate broadcaster named Mebo II North Sea International operated off the Dutch Coast and had quite a good time transmitting non-stop pop music. It seems that a few guys didn't like the stuff, so they quietly swam out to the ship (anchored in international waters), stuffed gasoline-soaked rags and explosives around the place, ignited the whole thing, and then snuck off. The 10 crew members took to lifeboats and waited for the fireboats. The fire was extinguished and the station is now back on the air—

still with non-stop pop music. The police located a rubber dinghy and frogmen's suits on a nearby beach and nabbed three suspects. Couldn't be the IMF group; they were in South America at the time.

FRENCH SPACE

Most of what we hear about space exploits comes either from America or Russia. However, there is a lot of space work going on in France. Not too long ago, French technicians fired one of their Dragon 2B rockets from the Kerguelen Archipelago (Antarctic) to investigate the Aurora Australis. They have also opened a new space station at Kourou, Guiana, from which they have launched a rocket that can be recovered from the ocean. The rocket got up to 70 miles and dropped into the sea 9 miles from the coast after a flight of 11 minutes, 15 seconds. Four small wings stabilize the re-entering vehicle and brake the speed slightly. A parachute opens at 13,200 feet and activates the braking mechanism. On landing in the sea, gas from an auxiliary rocket inflates a small buoy, and two radio transmitters start up.

Recently, the French flipped a 132-pound Peole geodetic satellite into a 466-by-497-mile orbit, using their new Diamant B rocket. With other launch sites at Hammaguir in the Sahara and Les Landes in the south of France, and with tracking stations scattered about in such places as Flores Island (Azores), France is number three in space—and trying harder.

Four more satellites have gone up: the D-2A, a scientific satellite; Eole, a meteorological thing; a D-2A polar orbiter; and a Stret research unit. They are also ready to go with the Symphonie, a French-Belgian-German project; and in conjunction with a U.S. Thor-Delta, up will go Meteosat, a 265-pound weather observer.

FUTURE HAM?

The Radiotrician Confederation has just asked the FCC for a rule-making procedure leading to the creation of two new classes of ham licenses. One would be a "beginners" class requiring no formal examination. The other would be a "code" class requiring 20 words per minute, knowledge of ham radio rules, and demonstrated ability to operate factory-built gear.

NEXT TIME TRY TOM-TOMS OR HAM RADIO

You would think that, with the multi-billion dollar communication network that the Pentagon has spread around the world, important messages would be almost instantaneously available in all quarters. Not so! According to a Congressional report, although the actual time lapse for an electrical transmission of a message around the world is about 5 minutes, handling delays have brought the figure up to 69 minutes. And that's for a "flash" message. The system needs about 100 minutes to send an "immediate" message the same distance.

NEW BATTLE IN THE NUMBERS WAR

Though much has been written by experts on the mysterious "numbers" stations that are supposedly sending secret messages to spies and counter-insurgency agents all over the world, very few transmitter locations have been pinpointed. All of this has led some cynics to suggest that the whole thing is a little bit of science fiction or psychological warfare. If this is so, one MARS group on tornado watch is wondering just who the enemy can be. One of the "number" girls (most of these stations use female announcers) created havoc by camping on 3205 kHz. Ironically, "that" number station almost certainly is operated by an agency of the U. S. Government. Try as they might, there was no one that MARS could complain to about the wanton QRM. (Submitted by Short Wave News Service.)

BELL & HOWELL TECHNICAL REPORT

Subject: New Home Entertainment Electronics Systems Program

Competitive Advantages:

- Features first Solid-State Color TV (315-square inch, rectangular screen) Kit for at-home training to build, keep.
- Helps prepare recipient for Color TV Service Business of his own. Covers solid-state circuitry in depth--also other Home Entertainment equipment. Fully updated.
- Provides three additional professional quality kits to assemble, keep, use.

COMPONENTS:

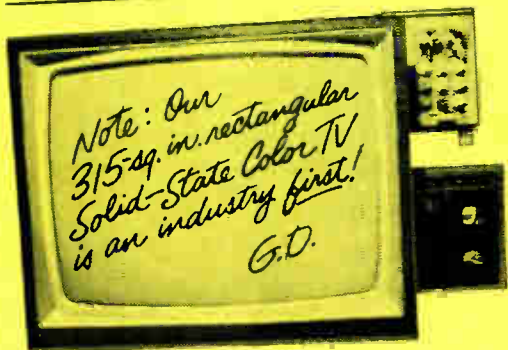

Specifications:

New 25" diagonal, ultra rectangular screen. 315-sq. inch viewing area. 25,000 volt, solid-state design, w/ 45 transistors, 55 diodes, 2 silicon rectifiers. 4 advanced IC's w/ 46 transistors, 21 diodes. 2 tubes: picture and high voltage rectifier. Solid-State VHF and UHF tuners. 3-stage solid-state IF. AFT standard. VHF power tuning. Also: "Instant On" circuit, automatic color control, noise limiter.

Descriptive analysis:

Modular plug-in circuit board design provides for more than 100 advanced solid-state devices. Insures premium color, sound control, exceptional reliability, easy access. Includes Hi-Fi amplifier for sound output, built-in dot generator, tilt-out convergence panel. Handy Volt-Ohm meter permits initial set-up and adjustment plus detailed troubleshooting. 315-sq. inch picture tube face transmits entire image. Push button channel advance. AFT module brings in perfect picture, sound

automatically. Easier to service than older, non solid-state sets. Quality components throughout.

Electro-Lab-at-Home: Components included:

The Electro-Lab® consists of three units, arriving in 16 shipments which recipient assembles, keeps. All components are professional quality. The circuit DESIGN CONSOLE contains built-in power supply, test light, speaker. Patented Modular Connectors permit plug-in to console to rapidly "bread-board" many different circuits. No soldering or messy un-soldering necessary.



The portable 5-inch, wide-band OSCILLOSCOPE is calibrated for peak-to-peak voltage and time measurements... offers 3-way jacks to handle test leads, wires, plugs. Images on screen are bright, sharp.



The lightweight TRANSISTORIZED METER combines most desired features of a vacuum-tube voltmeter and a high-quality multimeter. Features a highly sensitive, 4-inch, jewel-bearing d'Arsonval meter movement. Registers slightest power surge or lag on large, easily read dial. CONSENSUS: first class gear.



Program is designed to give:

- Understanding of electronic circuits in most home entertainment electronic systems
- Ability to analyze and troubleshoot a wide variety of advanced solid-state and other TV circuits
- Capability to understand and use test equipment and procedures with special emphasis on TV testing
- Ability to assemble, test and adjust the solid-state TV kit included with the program

MAIL CARD TODAY FOR ALL THE FACTS
No Postage Needed →

Color TV is going Solid-State—here's how to help yourself get ready for it:

There's nothing else like this exciting new program that offers the *first* 315-sq. inch Solid-State Color TV available for at-home training.

As you follow the simple, step-by-step assembly and testing procedures, you will soon become thoroughly familiar with the most advanced solid-state TV circuitry. And you'll help prepare yourself for a profitable Color TV service business of your own—either full or part time.

Why Color TV pays better.

Today, Color TV is the big seller. And tomorrow, when it goes all solid-state, the man who has mastered this circuitry, will be in demand. This, of course, is where the money is going to be made.

But, this new Bell & Howell Schools program will also give you the in-depth knowledge of the basics as well as TV circuit analysis. You'll get the theory and practical experience you need to handle radios, Hi-Fi's, stereos, tape recorders, B & W television as well as most other home entertainment electronic devices.

Build, keep your own 25" diagonal Solid-State Color TV Set

Whether you are a beginner, an experienced hobbyist, or a pro working in the field, you are going to be delighted with the performance you get from this new solid-state kit. So proud, you'll want to show it off to your relatives and friends.

The "specs" at left give a few of the facts. But there are many, many features besides these which you will not find in any set on the market today. Send for all the facts and this is the one you'll want.

You're ready for many kinds of Home Entertainment Equipment

This is a thorough-going program, put together by professionals, with completely up-dated components and materials. When you have completed it, you'll have a new kind of confidence in your ability to tackle almost anything related to electronics in the home. And I can assure that these devices are definitely on the increase!

In addition, you'll have the kind of sound technical background you need for either a career as a technician in the Electronics industry or a business of your own—either full or part time.

Note: TV picture is simulated.

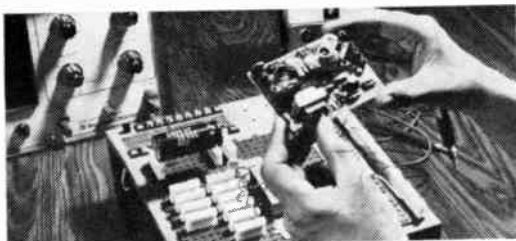

CONSIDER THESE ADVANTAGES:

Bell & Howell Schools' Electro-Lab-at-Home Plan gives you the most thorough background possible in solid-state Color TV. Everything comes to you by mail. No traveling. You go at your own speed and never miss a paycheck!

When you've completed your program, our Lifetime National Employment Service will help you locate in an area that interests you. This service is available at any time—now or in the future.

Approved for G.I. Benefits.

Our programs are approved for Veterans' Benefits. If you're a Vet, check the space in the card for full details.

Student Loans Available.

If you're a non-veteran and need financial assistance, you may qualify for a student loan. This may enable you to *learn now... repay later.*

Special Help Sessions.

These are scheduled regularly (Saturdays) at seven Bell & Howell Schools and in many other cities. Here you can get expert guidance by top instructors to help you over any rough spots.

Bell & Howell Schools offer you even more. Once you have finished your program at home, you may decide you want more advanced preparation. In this case, you can **earn transfer credits** to any one of our seven schools which are located all across the country.

Mail the postage-free card today for all the facts. There is no cost or obligation of any kind.



**BELL & HOWELL
SCHOOLS**

4141 Belmont, Chicago, Illinois 60641

FREE! MAIL CARD TODAY FOR ALL THE FACTS
No Postage Needed

322



OPPORTUNITY AWARENESS



Thoughtful Reflections On Your Future

Seventeenth in a Monthly Series by David L. Heiserman

Developing a New Idea

Do you have any suggestions on how an individual can raise money to develop a new kind of semiconductor device? I have the theory all worked out, and I've estimated it will take about \$15,000 for equipment and materials to develop the first working models. The scientists and engineers I've talked to seem to think I have a workable idea. However, I've been to several major electronics firms, and they all claim money is too tight now to justify a new R&D program. I'm not anxious to make a big fortune, but I can't even give it away. So, I'm stuck with trying to develop the device myself.

• Unless you are an engineer with a well-established reputation for turning ideas into dollars, I wouldn't suggest looking for direct financial support for your project. You might be able to set up an R&D firm of your own and sell some stock, but you'd have to convince your investors that they can expect a healthy return for their money.

Since you are willing to give away your idea, I suggest you take it to the chairman of the electrical engineering department of one of the major universities. Graduate students are anxious to find fresh research projects to fulfill their requirements for theses and dissertations. If you can convince them that your idea is good, the school will find a grant to support the work and some graduate students to direct it. You should be able to get full credit for working out the basic theory and, perhaps, collect a consulting fee.

You might also write up your idea in the form of a technical paper and submit it to some technical periodicals. Chances are you won't be paid for the writing, but you will receive formal credit as the originator of the idea.

Although giving away your idea might not make you rich, it will certainly provide a powerful bargaining tool when it comes to getting a higher paying job in the future. From this point of view, it seems better to give away your idea now than to hoard it so long that someone else has a chance to come up with the same thing.

FCC License Exam Schedules

How can I find out when and where I can take FCC license exams in my area?

• The FCC holds licensing examinations several times a week at 23 permanent field engineering offices and about twice a year at 90 different temporary testing centers around the country. Finding the time and location for examinations in your area is a two-step process:

(1) Write to the FCC office in Washington for a free list of local field offices and testing centers. Ask for: "FCC Field Engineering Offices." The address is: Federal Communications Commission, Field Engineering Bureau, Washington, DC 20554.

(2) When you receive the list, locate the nearest field engineering office and write to them for the time and location of the next few exams in your area.

The field office can also supply application forms and a list of references that will help you prepare for the exams.

Government Publications on Electronics

Can you tell me where I can obtain a list of electronics books published by the U.S. Government?

• The U.S. Government Printing Office publishes a free, 22-page catalog that lists all of

their current publications on the subject of radio and electricity. Be sure to specify "Price List 82—Radio and Electricity." Write to: Superintendent of Documents, Government Printing Office, Washington, DC 20402.

Info on Consumer Electronics Industry

There are many references to the facts and figures on career opportunities in consumer electronics, but I can't find an in-depth analysis of the growth of the industry itself. Is there such a publication?

The Electronic Industries Association (EIA) publishes a booklet entitled "Consumer Electronics." It outlines the history of consumer electronics from Thomas Edison to the present, and it uses dozens of tables and charts to show the year-to-year growth of the entire consumer electronics industry. The booklet also includes information about changes in production and marketing methods.

To obtain a copy of "Consumer Electronics", send 50¢ to Consumer Products Division, EIA, 2001 Eye St., NW, Washington, DC 20006.

Low-Paying TV Service Business

Why do TV and radio repair shops pay their technicians such low wages?

• Most TV and radio repair shop owners are caught in a trap between rising overhead costs and public resistance to increased charges. So it's the shaky economics of the business, and not tight-fisted shop owners,

that accounts for the lower wages in the service industry. Some shop owners, in fact, feel lucky if they can pay a few bills and still take home as much money as their technicians.

There is a growing trend toward paying technicians a percentage of the labor charges for each job he does. In this way, technicians who can't work fast and well don't make much money and soon get out of the business. Technicians who have the experience and know-how to spot a trouble and get it fixed in a minimum time, however, can do quite well with a percentage arrangement.

Shop owners usually like the arrangement because it gives them a small staff of highly competent technicians who build up the volume of business in a short time. And doing a large volume of business is the only way a shop can show a healthy profit.

If you're genuinely interested in doing TV and radio repair work—and if you're good—I suggest you look around for a good shop that will hire you on a percentage-of-labor basis. It's impossible to say what kind of percentage you can expect, and you might have to bargain with the owner to get what you want. The percentages run anywhere between 15% and 50% depending on your ability, what others in the shop are getting, and any side benefits (such as a small fixed salary) that the owner might offer. If your city or state operates a certification board for TV and radio shops, you might contact them to find out whether you're getting a fair deal.

VIDEOTAPED COURSES OFFER TECHNICAL UPDATING & GRADUATE DEGREE

RCA Institutes recently announced the availability to industrial firms of a series of 40 videotaped courses in science, engineering, and technology—the largest videotaped library available anywhere. A. L. Baker, President of RCA Institutes states that "The series will permit an industrial firm to present a tailored program of education (to) its employees in its own plant facilities, at times convenient to them."

The courses are designed to keep technical personnel up-to-date and enable the engineer to earn a degree by attending classes where they work. The Florida Institute of Technology presently grants full college credit for the graduate-level courses once the student satisfactorily completes a review-examination session on the campus. By attending the courses, an engineer can thus complete all classwork requirements for

the master of science in electrical engineering.

Each course consists of 12 two-hour videotaped programs that can be presented over a videotape-TV receiver system. In addition to the tapes, RCA Institutes also furnishes study guides, textbooks, exercise manuals, examinations, and other materials that are integrated with the tapes.

The courses themselves are designed to be supervised by an instructor selected by the sponsor of the program. The instructor's duties are to oversee the taped presentations, lead discussions, and administer examinations.

RCA Institutes anticipates that the cost of the program will be as low as \$50 per enrolled student per course. In many instances, this figure represents less than one-half the cost of a conventional on-campus course.

THE PRODUCT GALLERY

Thirteenth in a Monthly Series by "The Reviewer"

MAGNECORD 2001 TAPE DECK

(A Hirsch-Houck Lab. Evaluation)

The Magnecord Lab Series 2001 is a deluxe stereo tape deck with a two-speed hysteresis synchronous motor for driving the tape at $3\frac{3}{4}$ and $7\frac{1}{2}$ in./s and separate torque motors for the supply and takeup reels. The transport is solenoid-controlled via seven push buttons. The deck will accommodate tape reels up to 7" in diameter. And for full flexibility, three quarter-track tape heads are used.

Two tape tensioning feelers, together with two heavy flywheels, provide mechanical filtering to reduce flutter. One of the feeler arms operates a microswitch if the tape breaks or otherwise loses tension, shutting off the recorder. Differential band brakes stop the reels smoothly, minimizing the risk of tape breakage or spillage. Since the speed change is electrical rather than mechanical, speed changes can be made both while the tape is in motion and when it is stationary.

The all-solid-state electronic portion of the Magnecord 2001 is located below the transport. The transport itself can be installed at any angle between horizontal and vertical. At the rear of the deck's housing are the line inputs and outputs, while on the front there are two jacks for high-impedance dynamic microphones and two jacks for stereo headphones. The latter are designed to drive 600-ohm phones; but even with 8-ohm phones, the signal level available is sufficient for monitoring if not for serious listening.

Separate level controls are provided for the microphone and line inputs, each a concentric pair that allows individual channel adjustment. A monitor switch connects the line outputs to either the source or tape playback signals, simultaneously switching the two illuminated VU meters. Concentric with this control is the equalization selector which must be set to correspond with the tape speed selection.

Another switch allows recording on either channel while playing back through the un-



used channel or recording in a full stereo mode through both channels simultaneously. Red lights indicate the recording status of each channel. With external patching, sound-on-sound recordings can be made by recording from one track onto the other while adding new program material. Concentric playback level controls set the level at the line and headphone outputs.

The tape transport controls are mechanically interlocked to prevent accidental tape erasure or spillage in normal use. Nevertheless, Magnecord suggests waiting in STOP until the reels cease motion before going from either rewind or fast forward to any other mode. We found the transport to be quite tolerant of careless operation, although it was possible to depress some of the control buttons at times when they should have been immovable.

Laboratory Measurements. Our measurements on the Magnecord 2001 completely confirmed the manufacturer's specifications. In most cases the prototype deck we had far surpassed the published specifications.

With Ampex quarter-track alignment tapes, the playback frequency response was ± 1

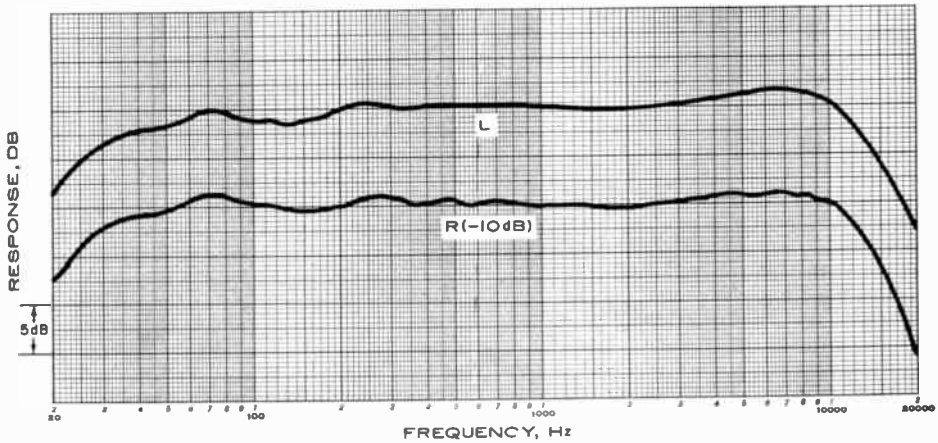
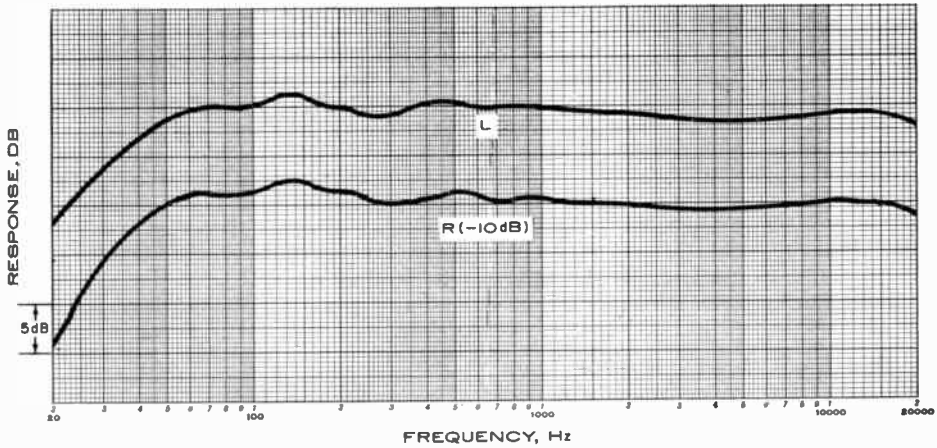

Curves shown at top and immediately above illustrate frequency response at speeds of $7\frac{1}{2}$ and $3\frac{3}{4}$ in./s, respectively, for test prototype of Magnecord 2001 tape deck. Note that curves are essentially flat from 50 to 20,000 Hz at $7\frac{1}{2}$ in./s (50-10,000 Hz at $3\frac{3}{4}$ in./s), varying by less than 3 dB.

dB from 50 to 7500 Hz at $3\frac{3}{4}$ in./s (Magne-cord tolerances are ± 3 dB over these frequency ranges). The deck is shipped with its bias set for low-noise tapes, such as 3M's No. 202, which we used for our tests. The overall record/playback frequency response was $+1.5/-3$ dB from 30 to 13,000 Hz at $3\frac{3}{4}$ in./s (rated ± 3 dB, 30-10,000 Hz by Magne-cord), and at $7\frac{1}{2}$ in./s, it was $+2/-3$ dB from 40 to 23,500 Hz (rated ± 3 dB, 45-18,000 Hz).

On our test deck, the standard 3 percent distortion reference level was reached at $+8$ VU, far off-scale on the meters. The signal-to-noise ratio, referred to this level, was 58 dB at $7\frac{1}{2}$ and 56.5 dB at $3\frac{3}{4}$ in./s. For best results, we suggest recording with average levels close to 0 VU since occasional peaks to full-scale or beyond will cause significant distortion.

Through the microphone inputs, at maximum gain, the signal-to-noise ratio was re-

duced by 2.5-4.0 dB, which represents very good performance. Rarely would the user want to use maximum microphone gain.

For a 0-VU recording level, the line inputs required 180 mV at maximum gain, while the corresponding mike input was 0.2 mV. The playback output from a 0-VU signal was 0.98 volt. Wow and flutter were very low. At $3\frac{3}{4}$ in./s they were respectively 0.015 and 0.07 percent (rated value was 0.25 percent), and at $7\frac{1}{2}$ in./s the wow was unmeasurable at less than 0.01 percent and flutter was only 0.045 percent (rated at 0.18 percent). The tape speeds were exact, and 1200 feet of tape was handled in fast forward or rewind in the rated time of 81 seconds.

With this caliber of performance on the test bench, it came as no surprise to find that the 2001 was a very fine sounding deck in actual performance. At $3\frac{3}{4}$ in./s we could

THE PRODUCT GALLERY

hear no change in the frequency range or noise level when recording stereo FM broadcasts, and only a trace of attenuation of the highest frequencies when recording interstation hiss on FM. This is an extremely sensitive, revealing test for recorder frequency response and distortion. At $7\frac{1}{2}$ in./s even the hiss was reproduced with negligible change. Without a doubt, the quality of the

2001 should satisfy the most critical ear.

The Magnecord 2001 is supplied with a walnut base for its list price of \$795. An optional cabinet mounting frame and a portable carrying case are also available. In its wooden base, the deck measures about $14\frac{1}{2}$ " high (with 7" reels in place) by $8\frac{1}{16}$ " deep by $9\frac{1}{8}$ " wide. Its weight of about 40 pounds attests to its rugged construction.

Circle No. 94 on Reader Service Card on Back Cover

HEATHKIT MODEL HM-102 R-F WATTMETER/SWR BRIDGE (A Hirsch-Houck Lab. Evaluation)

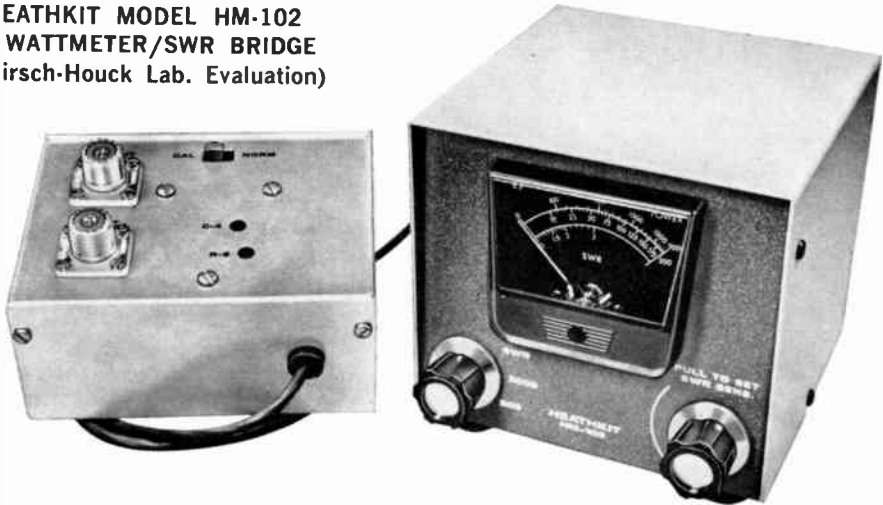

Heathkit's Model HM-102 r-f wattmeter/SWR bridge is an instrument that will undoubtedly be welcomed by many amateur radio operators. It features two switch-selected ranges to allow measurement of r-f output power from 10 to 200 watts and from 100 to 2000 watts. A built-in calibrator provides 10 percent accuracy throughout the 80-10 meter ham bands. The SWR bridge capability allows the user to properly tune his transmitter and match his antenna and transmission line impedances.

Test Results. We checked out the Heathkit HM-102 in tandem with a Drake Model W-4 wattmeter, a commercial unit with similar ranges. Power for the tests was supplied by a Heathkit SB-400 transmitter for the low-power range; and a Heathkit SB-200 linear amplifier was used to boost the power to check the high-power range. Loading for the basic measurements was supplied by a Heathkit "Cantenna" 50-ohm noninductive "dummy" load. Our measurements were also made on external antenna systems with an appreciable SWR to check the operation of the meter under operating conditions.

Our test frequencies were 3520, 7720, 14,020, 21,020, and 28,020 kHz, at each of which we took power readings on both meters connected into the same coaxial line.

Initially, the HM-102 was calibrated by us against the Drake meter on 7220 kHz at 100 watts into the 50-ohm load (the procedure recommended in the Heathkit manual). At frequencies of 21 MHz and below, the calibration held very well, with the two meters agreeing within about 1 percent on all bands at 100 watts. However, there was a difference of about +11 to +12 percent with the HM-102 on the high-power range (relative to the Drake meter, not an absolute standard), with power of 600 to 800 watts. The Drake meter has a reverse power measuring capability from which true radiated power can be determined by subtracting reverse power from forward power readings and, with the aid of a supplied nomograph, SWR can be determined from the two power readings not featured in the HM-102.

There was also a variation in SWR readings between the two instruments. A change in SWR indications with the Heathkit meter was also observed when power was changed

from 100 to 600 watts; a higher power resulted in a slightly higher SWR reading with constant load conditions. The minimum power needed to obtain a SWR measurement with the HM-102 was 7 watts (rated at 10 watts).

The \$29.95 (in kit form) Heathkit r-f power wattmeter/SWR bridge is certainly a very good buy for the money giving the user a most useful instrument—especially with a 50-ohm load where power readings are meaningful.

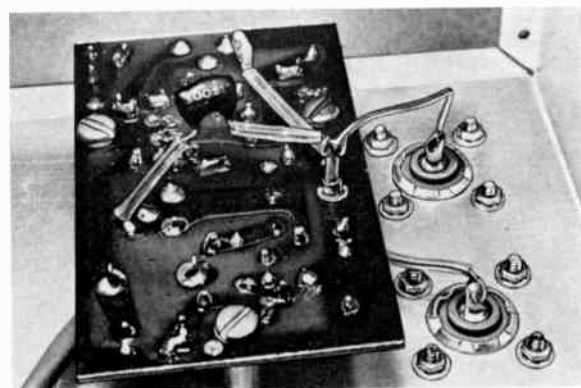
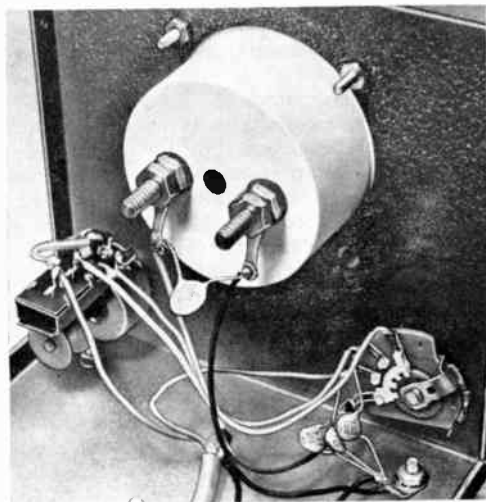
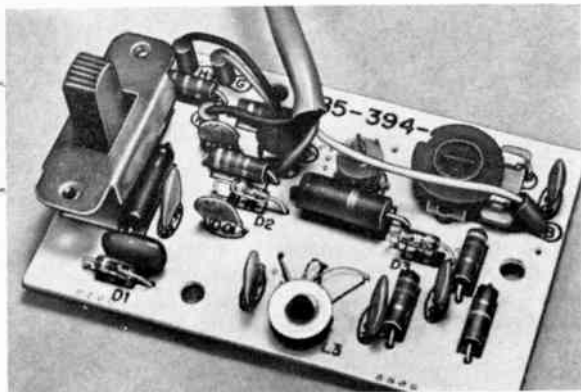

Heathkit HM-102 r-f wattmeter/SWR bridge employs single PC board (above left) which mounts inside connector box (left). Five-conductor cable interconnects connector box with meter case as shown in foreground in above photo. Only items in meter case are sensitivity control, function switch, and meter movement, plus bypass capacitors.

Circle No. 95 on Reader Service Card on Back Cover

RAMKO RESEARCH COLLIMETERS TAPE HEAD AND GUIDE ALIGNERS

Model II for Cartridge Players
Model V for Cassette Decks

The modern tape recorder/player—whether open-reel, cassette, or cartridge type—is a fairly delicate precision device. In use, it requires more careful handling than most of the other items in your hi-fi system. Small mechanical shocks that would have no effect on amplifiers, tuners, and receivers can knock out of alignment tape heads and guides, resulting in the loss of high frequencies. For this reason, it behooves the tape deck owner to have these critical items periodically checked and realigned to insure peak performance from his equipment.

Until Ramko Research designed and made

available low-cost, precision collimeters for aligning tape heads and guides, the owner of a misaligned tape deck had to depend on factory service centers. But now, with the aid of the proper easy-to-use collimeter from Ramko, the knowledgeable tape deck owner can perform his own realignment with confidence and obtain almost perfect results.

We tested two collimeter models, both retailing for only \$9.95 each. The first of these was the Model II Collimeter which was designed specifically for use with cartridge players. The collimeter is a simple precision electro-optical jig containing a simple battery-powered light source. One end of the housing is fitted with a clear-plastic optical prism onto which guide lines have been scribed.

To use the Model II, the operator must first remove the cover from his cartridge

player to gain access to the tape heads. The jig is then placed on the deck of the cartridge insert slot and moved up to the tape head. In this position, the user can quickly and accurately set head height, zenith, and azimuth merely by viewing the head gap positioning with respect to the scribed lines through a "window" in the prism. The whole operation, including the tape guide adjustments, can be performed in less than ten minutes.

With the exception of the head zenith adjustment, the collimeter is used with the light source turned on. For the zenith adjustment, the lamp is turned off, and when correct attitude is obtained (tape head exactly parallel to the face of the collimeter), the lamp automatically switches on. A pair of thin metal sensors contact the head housing to switch on the light source when precise zenith adjustment is accomplished.

The Model V Collimeter, designed specifically for use with cassette decks consists of five items: the optical jig, a calibration block, a base support, a small penlight, and a felt marker. Again, to use the collimeter, it is necessary for the operator to gain access to the tape heads and guides.

The optical jig is mounted on a heavy plastic base which is designed to slip into the cassette slot in the same manner as does a cassette tape. Various index lines are scribed onto the optical system to permit the user to quickly and accurately perform head height, zenith, and azimuth—as well as tape guide—adjustments with the aid of the small penlight. The felt marker is used to check alignment. After the adjustments have been performed, the user lightly coats the faces of the tape heads and plays a good cassette to check the tape-wear pattern on the heads. Touchup adjustments are then performed until the wear pattern is even over the entire tape gap surface of the head.

Both collimeter kits are supplied with easy-to-understand and follow instructions. They



Ramko Research Collimeter II (cartridge) and Collimeter V (cassette) tape head and guide alignment kits are shown above and below, respectively, in plastic cases.



are packed in clear-plastic protective boxes. The nominal \$9.95 invested in one of the Ramko collimeters can keep a good tape machine sounding great for a long time to come.

Circle No. 96 on Reader Service Card on Back Cover

CALGON "THERMO-TRAP" CHEMICAL HEAT SINK PASTE

Of late, chemicals have become an important part of electronics technology. There are now available contact cleaning and burnishing agents, potentiometer cleaners, coolants, and heat-absorbing pastes for soldering, brazing, and welding operations. In the latter category is "Thermo-Trap" made by Calgon Corp., selling for \$3.20 in a 10-oz tube through air-conditioning/refrigeration and heating/plumbing suppliers.

Thermo-Trap is a paste-like substance that

has an extremely high capacity for absorbing heat. Applied to the work surface, such as leads of transistors and IC's, between the area to be heated for soldering and the component, the paste soaks up heat before it can get to the component. Heat-sensitive components and materials on the side of the paste away from the heat stay cool and safe.

The paste is easy to apply and adheres well to the work surface. The amount of paste to be used varies, depending upon the thickness and heat-conducting properties of the metal to be welded, brazed, or soldered,



the temperature, and the length of time the heat is applied. In conventional soldering, very little Thermo-Trap is needed.

Thermo-Trap is odorless; it does not melt or run. Nor does it affect the circuit on which it is used in any way. The paste can be left in place after soldering, or it can be cleaned away with a damp cloth.

Anyone who works with heat-sensitive devices—and who doesn't these days?—will find Thermo-Trap a welcome item on the workbench. Its use frees the user's hands from having to juggle a heat sink while at the same time attempting to handle the solder and a soldering iron, an operation that heretofore required three hands.

Circle No. 97 on Reader Service Card on Back Cover

LITTON BATTERY-POWERED MINI-CALCULATOR

An electronic mini-calculator that provides a printout tape of calculations has been introduced by Monroe Division of Litton Industries. Weighing less than 2 pounds, the pocket-size Model 10 calculator (affectionately known as "The Shrimp") measures only 4" wide by 8 $\frac{3}{4}$ " long. It can easily be held in the palm of a hand. And the calculator can operate on its own batteries or directly from ac line power.

The \$379 asking price for The Shrimp includes a Model BC-1 battery quick-charger. The Shrimp can operate 4-5 hours on its own batteries without recharging. Recharging the batteries takes 3-4 hours. (The calculator can also be operated while the batteries are being charged.)

The 12-digit calculator has add, subtract, multiply, and divide functions, and offers automatic constants in multiplication and division as well as automatic decimal points.

A thermal printing technique transfers numerals and symbols onto paper tape quickly and quietly to provide a record of calculations performed. The tape is provided in easy-to-replace cassettes.





Thirteenth in a Monthly Series by J. Gordon Holt

FACTORY ADJUSTMENTS AND MALADJUSTMENTS

SOME TIME AGO, our sister publication *Stereo Review* published short reports on twelve cassette decks, including frequency response curves of each. To the critical audiophile, the most striking thing about those curves was the fact that not one of them was truly flat within the major part of the recorder's frequency range.

Subsequently, I was able to borrow (from the manufacturer) one of the better cassette machines covered in that report and run a few curves on it myself. Not surprisingly, it too exhibited some rather substantial response deviations within its working range. But what was more significant was the fact that its response deviations were different from those reported in *Stereo Review*.

So, on a well-founded (by that time) hunch, I ordered a service manual from the manufacturer and went through the rather lengthy procedure of setting up all of the recorder's internal adjustments as described in the manual. The result confirmed my hunch. The setup procedures as outlined by the manufacturer did not insure peak performance from the machine. After following the procedures as carefully as possible, I ended up with a machine that played back its own recordings with one channel's high end up several dB at 10,000 Hz and the other channel's high end a couple of dB down at the same frequency. In other words, if the factory production line used the setup procedures described in their service manual, it is inevitable that different production samples of that recorder would differ in performance and that a given sample would more than likely be improperly adjusted.

At this point, I abandoned that manufacturer's instructions and tried setting up the machine according to instructions furnished by another manufacturer who used the same basic transport mechanism and electronics board, but whose recorder had shown (in the *Stereo Review* report) quite uniform response. The setup according to that procedure actually took less time than the other one, and the final measured re-

sponse was smoother than had been reported for the other, supposedly better machine.

Clearly, there is a moral to this. The recorder which at first measured rather poorly for *Stereo Review* and in my own tests was not performing up to anything like its full potential because the factory wasn't setting it up properly. The other machine, which initially tested far better, was superior only because its manufacturer went to the trouble of setting it up accurately.

Not Unusual. This case was by no means unusual. Of the many tape recorders I have tested, including some high-priced "perfectionist" open-reel machines, not one would deliver, even with the recommended tape, the ultimate level of performance of which it was capable. Some did very well, admittedly. But every one could be improved—audibly as well as measurably—by some re-touching of bias, level, and equalization adjustments. And as an interesting sidelight, I should mention that the best-adjusted new tape machine I have ever encountered was a cassette unit. Professional recorders, as a rule, were among the poorest when it came to being properly adjusted.

There's every reason for a manufacturer not to set up professional machines. Service manuals are supplied with them as a matter of course, and it is assumed that the buyer will set his machine up for his favorite tape anyway before he even tries to make a recording. Professional recorders are set up roughly at the factory only to make sure the adjustments operate properly. The buyer knows that every tape calls for its own special adjustments, and he is (usually) qualified and equipped to make them.

Not so the home user! The average audiophile assumes that the recorder he buys has already been set up—if he thinks about it at all. (Many people are not even aware that nearly every recorder has internal adjustments for trimming the record and playback electronics for optimum performance with a given tape.) By the same token, the manu-

facturer of any recorder for home use realizes that the buyer will probably not be prepared to do his own adjustments and does them for him.

Unfortunately, the manufacturer doesn't usually feel as much obligation to wring every iota of performance from his product as is expected by the consumer who pays \$100 to \$800 for it. Pride of workmanship, although paid much corporate lip service, is a rare commodity on the production line. The perfectionist approach is envisioned with horror by most production managers as a "Grand Bottleneck" on the assembly line—a horrendously cluttered corner where "Old Hans" sits puffing on his pipe and taking all afternoon to diddle \$800 perfection into a \$100 product. But simply because absolute perfection is impractical on the assembly line is no reason for throwing up hands and saying, "To hell with it. We claim plus or minus 2 dB, so that's good enough for an assembly-line standard." (Remember that plus/minus 2 dB allows for a very audible 4-dB variation.)

A Major Difference. Of two recorders, both of which are capable of plus/minus 2 dB response from 30 to 18,000 Hz, one may be quite bumpy in response between those frequencies without exceeding the dB limits, while the other may be capable of a remarkable plus/minus ½ dB from 50 to 12,000 Hz if accurately adjusted. This is, in fact, a major difference between some recorders whose response specs, based only on bass and treble limits, appear to be identical. It

is a sad commentary on something or other that plus/minus 2 dB seems to be a touchstone for practically all recorder manufacturers, whether or not their machines are capable of doing much better. The attitude seems to be, "If it meets specs, we've fulfilled our obligation to the buyer."

In many cases, there is not even that much idealism. It is apparent from published discrepancies between some manufacturers' specs and magazine test results that the specs are based on *maximum attainable* performance because actual production samples often don't even come up to the specs. These are units that the buyer should be wary of—though the failure of one sample to meet specs (as tested) doesn't necessarily indict that particular model.

Generally, though, published performance claims reflect an expectation of average production, and few manufacturers will knowingly pass a product that doesn't at least meet its specs. What is rather disappointing is that most production samples *could* be better—sometimes substantially so—than they are.

Many recorder manufacturers now specify the brand and variety of tape for which the machine is adjusted and there is no reason to expect that the recorder will function perfectly with any other tape. You can, however, expect decent performance with the recommended tape, and it is no great problem to check on it in the store before you take your recorder home. Record a few minutes of the steady inter-station hiss from a non-muting FM tuner. Then unwind and play

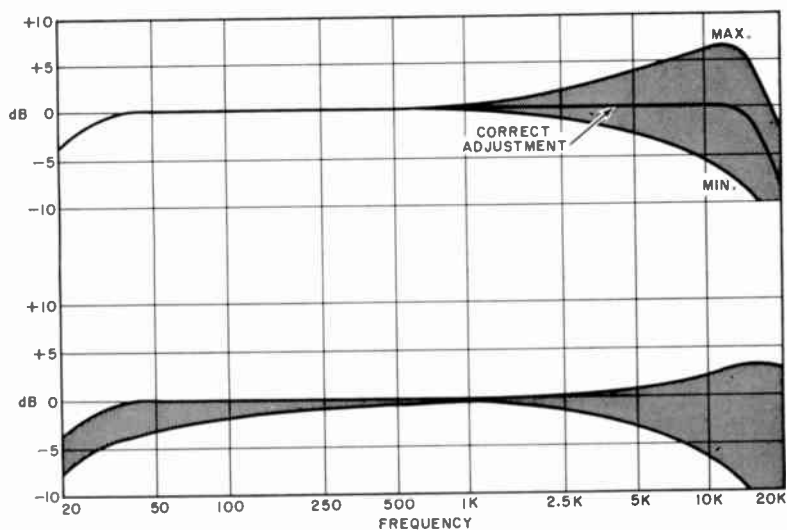

Curves at top show the range of high-end responses available through a typical recorder's Record Equalization adjustment. Lower curves show how, for a given recorder setup, the frequency response can vary by a large amount just by changing brand and type of recording tape.

this back while switching from the tuner to the tape. With the volume levels matched (and using the Dolby, if built in, for recording and playback), there should be little perceptible high-end difference between the original and the playback. If there is, it is more likely a sign of recorder misadjustment than of an inherently poor machine.

If you happen to be the kind of person who can hear, and is irritated by, a dB or so of change at the high end, then you may be lucky enough to find a service center where you can have any good recorder optimized for your favorite tape for a small fee. Otherwise, you'll have to learn how to do the recorder setup yourself, using rented or borrowed test equipment. You can buy the service manual for your recorder from the manufacturer at a modest cost—if, of course, he hasn't become cynical about uninformed diddlers who mess up their units and then return them under warranty for the factory to straighten out.

Other Maladjusted. As you've probably guessed by now, factory maladjustment is not unique to tape recorders. It is in fact rather common in any components that require adjustment for optimum performance. And the more adjustments there are, the more likely it is that they are not correct and the more difficult they are to make properly.

Some power amplifiers may have as many as six or more adjustments for such things as push-pull symmetry, bias, and phase-inverter balance. Since it is possible, with an amplifier, to meet very high standards mere-

ly by using precision resistors and capacitors in critical circuits, manufacturers who elect to make these parts adjustable do so in order to achieve extremely high levels of performance.

But with something like a tuner, where considerable precision is needed even for adequate performance and there may be ten or more critical adjustments, the care with which these are done at the factory can have more to do with how well the tuner performs than its inherent capabilities. As with tape recorders, it is rare that a tuner is delivered in such good alignment that it can't be perceptibly improved by touching up some of the adjustments. This is something that very few audiophiles are equipped to do. Tackling an FM alignment without the necessary test instruments is guaranteed to be disastrous. (The only exceptions are some kits which supply detailed instructions for final trimming with a minimum of test gear.) For some reason, it is generally easier to get a tuner aligned properly by an authorized factory repair station than it is a tape recorder. Perhaps this is because tuner alignment instructions call for approaching as closely as possible a not-quite-attainable ideal (the perfect i-f bandpass waveform), whereas the tape recorder serviceman is usually content to meet the rather generous published specs. In any case, it isn't fair to judge the inherent quality of any adjustable component—tape recorder, tuner, amplifier, or color TV receiver—until and unless you are reasonably certain it is properly aligned. And alignment is always cheaper than a trade-in. ♦

SIX-ELEMENT HEAD STANDARD ON NEW AMPEX CASSETTE DECKS

A revolutionary six-element head is incorporated into three new Ampex Corp. cassette decks and systems for the consumer market. All six elements of the new head are arranged in the same head block. Combined with the Ampex dual-capstan tape drive system, the tape is always being pulled across the head in the operating direction with equal contact on all elements. This provides exactly the same recording and playback characteristics in both directions.

The new head design avoids alignment problems often encountered in systems using separate erase heads or employing mechanical means of moving the heads to achieve bidirectional record and play functions. Under development for three years, the six-element head uses

the Ampex "deep-gap" design similar in construction to professional equipment. It insures reproduction of the full range of frequencies for a minimum of 1000 hours.

The six-element head is standard with the new Ampex Micro 155 deck, the Micro 335 stereo deck with 12-cassette changer, and the Micro 187R complete stereo system.

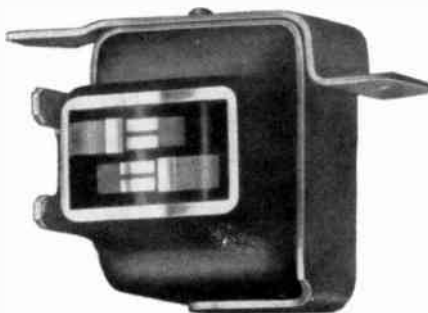



One Hundred Eighty-third in a Monthly Series by Lou Garner

ALTHOUGH not as widely used as bipolar types, field-effect transistors (FET's) are exceptionally versatile devices. With moderate to very high input and output impedances and relatively low-current requirements, FET's offer the circuit designer performance characteristics comparable to those of vacuum tubes coupled with the low-power requirements and high efficiency of bipolar units. Increasingly popular with professional design engineers, FET's may be used as dc, a-f, r-f, VHF and UHF amplifiers and oscillators; as modulators, mixers or detectors; as switches, gates and choppers; and as variable resistors, voltage regulators and current limiters. Fully compatible with other devices, they may be used with UJT's, standard bipolars, SCR's, IC's, etc.

Whether you identify yourself as an electronics fan, experimenter, hobbyist, gadgeteer, technician, or practical engineer, then you should welcome four recent offerings from a West Coast manufacturer, Siliconix, Inc. (2201 Laurelwood Rd., Santa Clara, CA 95054)—a new FET handbook and three kits of top quality FET devices at bargain counter prices.

Entitled *An Introduction to Field Effect Transistors*, the handbook is a 128-page, soft-cover, plastic-bound guide to the operation and application of FET's and related semiconductor products. Written at an intermediate, rather than elementary, level, the handbook should be of particular value to advanced experimenters, serious hobbyists, technicians, and practical engineers. Design equations are given where applicable, while mathematical treatments are featured in most of the theoretical sections. Numerous charts, graphs, tables and circuits are used to illustrate the text. Although a variety of valuable circuits is included in the volume, most are presented in basic form rather than as practical construction projects.

The sawtooth waveform generator illustrated in Fig. 1 is typical of the circuits described in the handbook. Suitable for use as the linear sweep generator in a solid-state oscilloscope, the circuit features a FET source follower buffer amplifier, Q1, a FET current limiter, Q2, and a UJT relaxation oscillator, Q3. Its repetition rate (or frequency) is determined by R2's value and C2's capacitance. In practice, C2 is switch-

Fig. 1. This sawtooth generator is typical of circuits described in new FET handbook available from Siliconix, Inc.

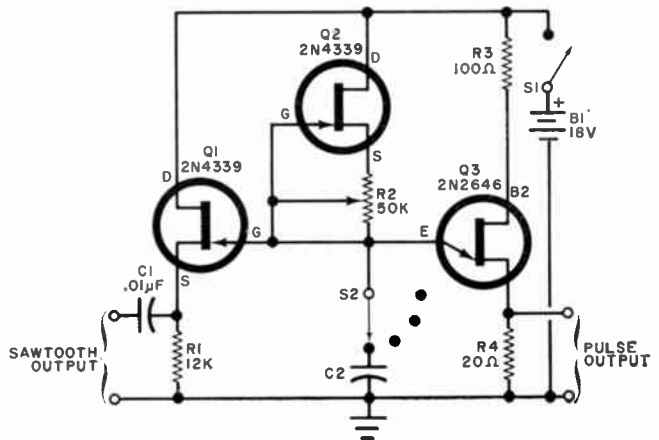

Automatic Tri-Speed Scan Action



16 big channels in three bands with push button program control

Hear it now!

A UHF, High/Low VHF monitor in one handsome, easy-to-operate package.

Our new Monitoradio/Executive Scanner, Model TME-16 H/L/U, doesn't miss a trick on transmission.

It conducts an automatic, or manual, search for active signals on your choice of frequencies in three busy bands. It stops to hear the transmitted action, loud and clear . . . then automatically resumes the search.

Each of the 16 crystal controlled channels is push button equipped for programming any channel "in" or "out" of service. Push buttons, too, for programming either of the three bands.

Tri-speed scan action speeds the signal search to "super-scan" the channels you want most—eliminates signal sampling of channels you choose to temporarily "program-out".

Best of all, it does the complete monitor job that formerly required 3 receivers—only \$219.00. Crystals \$4.95 each.

Hear it now—at your favorite Regency retailer.

Ask for our complete color catalog of 25 monitor models

Regency

ELECTRONICS, INC.

7900 Pendleton Pike

Indianapolis, Indiana 46226.

CIRCLE NO. 23 ON READER SERVICE CARD

selected with values from, say, 0.001 to 0.5 μ F.

Siliconix's three FET Experimenter Kits are similar except for the numbers and types of devices offered in each. Kit #1, the smallest and least expensive, contains six devices in all, including two general purpose amplifiers, two VHF amplifiers, a VCR and a

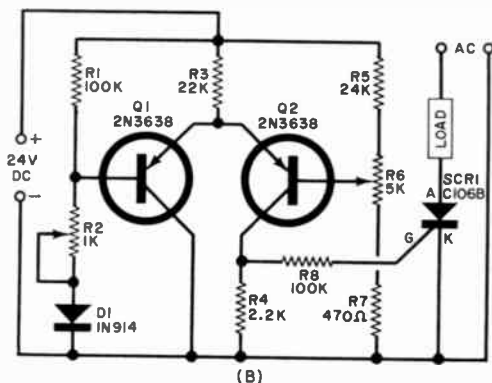
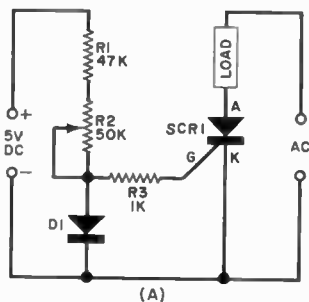

Fig. 2. When temperature rises above preset level, these circuits switch off load power. Circuit (B) is much more sensitive than (A).

current limiter (CL). A matched dual FET is featured in Kit #2, together with seven other units, including three general purpose amplifiers, a VHF amplifier, a switching type, a VCR, and a CL. Featuring an operational amplifier IC, Kit #3 also includes two general purpose amplifiers, a UHF amplifier, a VHF amplifier, a low resistance analog switch, a CL, and a matched dual pair.

The FET Experimenter Kits are available with or without the new handbook, but all three kits include a complete set of specification data sheets and useful application notes. Kits #1, #2 and #3 are priced at \$6.50, \$11.50 and \$16.50, respectively, with handbook, or at only \$5.00, \$10.00 and \$15.00 less handbook—a 50% savings compared to regular net prices. The FET handbook may be purchased separately at \$2.50/copy. If you

don't have a local Siliconix distributor, you can purchase the kits and handbook direct from the manufacturer by sending your order and payment to Siliconix, Inc., P. O. Box 185, Agnew Station, Santa Clara, CA 95054. California residents should add 5% sales tax to their remittance.

Readers' Circuits. If our mail is any criteria, the average reader of this magazine must be a cut or two above the usual electronics hobbyist. Instead of slavishly following published circuits, he adapts, experiments, modifies and, often, develops new approaches by combining circuit ideas from several sources. Generally, he is quick to spot typographical or drafting errors, indicating a good grasp of basic theory.

A recent letter from reader Duane Allen

is typical. Duane writes, in part, "I have enjoyed POPULAR ELECTRONICS since it was introduced over fifteen years ago. I particularly read your Solid State section and have found many good ideas there. Often a seemingly small 'think' can lead to a solution of a more complex problem."

Duane has summed up succinctly the purpose of our "Reader's" and "Manufacturer's Circuits." These are offered as "small thinks" rather than as complete construction projects. They are intended to stimulate your thinking, to offer solutions, and to provide starting points for the development of your own designs. You may find that some of the circuits are more critical than others, requiring a certain amount of experimentation with component values to achieve optimum performance. Others may require selected

Fig. 3. Circuit (A) can be used as audible timer or electronic metronome. Circuit (B) is make-break intrusion alarm (opening loop allows Q1 to fire and trigger on SCR1 which powers load.)

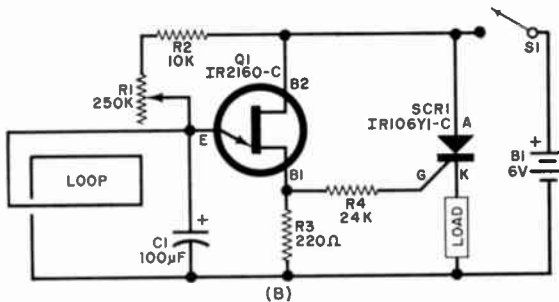
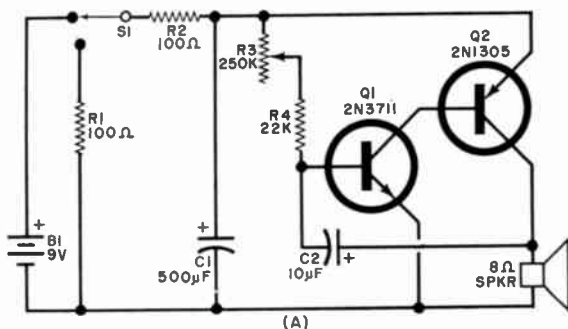

10 CHANNELS — FM MONITOR RECEIVERS



*Pat. Pending

SONAR-SCAN™

- ★ PRIORITY CHANNEL—LOCKS OUT ALL OTHER SIGNALS*
- ★ CARRIER DELAY—YOU HEAR MOBILE CALLBACKS*
- ★ MANUAL SELECTION BY SLOW SCAN TECHNIQUE*

A proven professional performer with the most advanced technology in design, circuitry and solid state electronics assures flawless performance you can hear with extreme clarity • SONAR-SCAN will search and automatically lock a signal on any of 10 pre-programmed channels • Noise free squelch • 10 crystal controlled channels • Adjustable scan sensitivity • Narrow band operation • Operates from 117 VAC or 12 VDC, negative ground only

designed for:

- Police, Fire and Municipal Depts.
- County, State & Federal agencies
- Commercial & Industrial applications
- Other unlimited uses

FR-2516
(25-50MHz) **\$159⁹⁵**

FR-2517
(150-175MHz)

Comes with AC and DC power cables, mounting bracket, less crystals. Crystals \$5.00 ea.

SONAR RADIO CORP., 73 Wortman Ave., Bklyn, N. Y. 11207
Please send information on SONAR-SCAN FM Monitor Receivers.

Name _____ Dept. 402

Address _____

City _____ State _____

CIRCLE NO. 25 ON READER SERVICE CARD



How to prepare for today's competitive job market, tomorrow's new opportunities in electronics

Competition for jobs and promotions is severe in the electronics industry today. But experts say that exciting new electronic products will create thousands of new jobs in the next few years.

One thing is certain: In good times or bad, the best opportunities come to the man with an advanced, specialized knowledge of electronics. He has a better chance of survival in a recession and will profit more in times of prosperity than the man with ordinary qualifications.

But how can you get the additional education in electronics you need to protect your future—and the future of your family? Going back to school isn't easy for a man with a job and family obligations.



College Credits for CREI Students

Recently CREI affiliated with the New York Institute of Technology for the express purpose of making it possible for CREI students to earn college credits for their studies. The New York Institute of Technology is fully accredited by the Middle States Association of Colleges and Universities and is chartered by the New York State Board of Regents.

For the many CREI students who are not interested in college credits, but simply in improving their knowledge of advanced electronics, this affiliation with NYIT will provide additional assurance of the high quality of CREI home study education.

If you want to know more about earning college credits for CREI study, check the appropriate box when you mail the postpaid card for complete information on CREI Programs.

CREI Home Study Programs offer you a practical way to get more education without going back to school. You study at home, at your own pace, on your own schedule. And you study with the assurance that what you learn can be applied on the job immediately to make you worth more money to your employer.

You're eligible for a CREI Program if you work in electronics and have a high school education. Our FREE book gives complete information. Mail post-paid card for your copy. If card is detached, use coupon or write: CREI, Dept. E1209B, Wisconsin Ave. & Tilden St., Washington, D.C. 20016.

Founded 1927

CREI

Accredited Member of the
National Home Study Council



Free book tells all about CREI programs. For your copy, tear out and mail postpaid card or write: CREI, Dept. E1209B Wisconsin Ave. & Tilden St., Washington, D.C. 20016

CREI, A Division of the McGraw-Hill Continuing Education Company

Dept. E1209B, Wisconsin Ave. & Tilden St., Washington, D.C. 20016

Please mail me free book describing CREI Programs. I am employed in electronics and have a high school education.

Name _____ Age _____

Address _____

City _____ State _____ Zip Code _____

Employed by _____

Type of Present Work _____ G.I. Bill

- I am interested in College credits for CREI study. Space Electronics
 Electronic Engineering Technology Computers Industrial Electronics
 Nuclear Engineering Technology Electronics Systems Engineering
 Non-technical course in computer programming CATV Engineering

APPROVED FOR TRAINING UNDER NEW G.I. BILL

devices or careful layout. But you shouldn't find any of the circuits boring.

Needing a temperature monitoring control for a high-altitude balloon flight, Duane exercised his ingenuity and developed the circuits illustrated in Fig. 2. Designed to switch off electrical loads when a monitored temperature rises above a preset value, the circuits are relatively simple and, according to Duane, quite reliable.

In Fig. 2A, diode *D1* is used as a temperature-sensing device. The diode forms a voltage divider in conjunction with fixed resistor *R1* and temperature adjustment *R2* to supply a dc gate voltage to *SCR1* through current limiting resistor *R3*. The SCR, in turn, controls the load current. In operation, *R2* is adjusted until *SCR1* "fires" at the desired operating temperature, furnishing power to the load. An increase in *D1*'s temperature at this point reduces its effective resistance, thus dropping gate voltage and allowing the SCR to switch off on the next negative half cycle. Without adequate gate voltage, the SCR remains off until *D1*'s temperature falls to its preset level.

Duane obtained similar performance, but with much greater sensitivity, by adding a modified op amp to his basic temperature control, as illustrated in Fig. 2B. Here, the variable bias voltage obtained from temperature-sensitive voltage divider *R1-R2-D1* is

amplified by *Q1-Q2* and used as the SCR's gate control voltage. According to Duane, the second version is so sensitive it will react to heat from one's finger placed near *D1*.

Standard components are used in both designs. The SCR's load may be a heater coil, relay, solenoid, universal motor, or any similar device requiring no more than 4 amperes and capable of operation on rectified (pulsating) dc.

While neither version is overly critical in regard to layout or lead dress, professional wiring techniques should be followed during assembly for optimum performance. The SCR should be heat-sinked and, naturally, the sensor (*D1*) must be placed at the point where temperatures are to be monitored.

A well-regulated dc source should be used for the control circuit's power supply, but the SCR may be operated from a conventional 120-volt ac line, preferably through an isolation transformer for maximum safety.

Suitable for use either as an audible timer or electronic metronome, the circuit given in Fig. 3A was submitted by reader R. K. Kirschman (1725 Franck Ave., Santa Clara, CA 95051). He writes that this was the best of a number of different designs he has tried in his home laboratory.

Referring to the schematic diagram, *Q1* and *Q2* serve as a complementary relaxation



MAKING "WAVES"

CADENCE—the musical instrument speakers

Making better, clearer, amplified sound waves is the **THING** Cadence does... better than anything else in the industry. Cadence Speakers are built to withstand heat from sustained notes at a high power level and the vibrations and stresses which are continually placed upon them. Cadence is guaranteed **one full year** at the power level specified. This proven speaker family has been selected by the manufacturers of most of the world's fine amplified music instruments.

If making beautiful, clear sound waves is your thing, ask for **CADENCE SPEAKERS**. For complete information and the name of your Cadence Dealer, write:



UTAH ELECTRONICS DIVISION
Utah-American Corporation
1124 East Franklin Street
Huntington, Indiana 46750

oscillator, with a repetition rate determined by the time constant of feedback network C2-R3-R4. While R2 and C1, a standard L-type filter, may seem superfluous in a battery operated design, Kirschman indicates that these were added to offset the comparatively high internal impedances of some small commercial transistor batteries, thus insuring a sharp, loud "click" on each cycle. Resistor R1 was included to discharge C1 when the circuit is switched off, thus preventing continued operation on C1's charge.

With neither parts placement nor wiring dress critical, the metronome may be assembled using any standard construction technique.

After assembly and check-out, the metronome may be calibrated using a watch or clock with a sweep second hand. For best performance, calibration should be at the unit's normal (room?) operating temperature, for this type of circuit is temperature sensitive to some degree.

Having received comments from a number of readers who tried his burglar alarm circuit, reader Cyril H. Goulden, Ph. D., L.L. D. (10 Kitimat Crescent, Ottawa 6, Ontario, Canada) decided to modify his original design, as published in our March, 1970 column. His revised circuit is illustrated in Fig. 3B.

The principal change from Dr. Goulden's earlier circuit is the addition of a UJT time delay network between the sensing loop and the SCR's gate electrode. In his original version, false alarms could be set off accidentally by switch or contact vibration.

Circuit operation is straightforward. As in the first version, the "loop" is a closed conducting path around the protected room or building, consisting of series-connected normally closed microswitches or contacts on doors, windows, and other access openings, tape foil on the larger windows, and so on. A break in this loop by an intruder permits C1 to charge through R1 and R2, applying emitter voltage to Q1 and switching the UJT to a conducting state. As Q1 conducts, a dc voltage is developed across R3, furnishing gate voltage to SCR1 through current limiting resistor R4 and "firing" this unit, thus applying power to the load, which may be a lamp, relay, solenoid or similar unit. If a relay is used here, it can serve to switch a separate heavy-duty alarm device, such as a loud buzzer, gong, or bell.

Inexpensive commercial components are used throughout the circuit. Switch S1, which serves both as the main power switch and as a "reset" switch, may be any standard spst type, although a key-operated unit is preferred for greatest security. The six-volt power supply, B1, should be a lantern battery for maximum service life.

(Continued on page 96)

ALLIED RADIO SHACK

ISSUES A NEW AND DIFFERENT CATALOG!



The new buying Guide for kit builders, Hams, hobbyists, do-it-yourselfers, "fix-it men"! Lists thousands of handy and wanted "little things" most stores don't stock. Like tubes and transistors, cables and plugs, adapters and antennas—you name it—the things that keep equipment working. Or make it work even better. Or DO MORE. If you own anything electronic or electrical, you need this catalog!

ALLIED RADIO SHACK

Dept. PE-7

AMERICAN CORPORATION

2725 W. 7th St., Fort Worth, Texas 76107

Send me your FREE Spring/Summer Cat. 212

Name (print) _____

Route No. _____ Box No. _____

Street _____ Apt. No. _____

City _____ State _____ Zip _____

CIRCLE NO. 3 ON READER SERVICE CARD

ANOTHER SUPERB VALUE from **Olson** Electronics



ONLY
\$12

**DELUXE
TRANSISTOR
CHECKER**

Compact, self-contained, self-powered dynamic transistor checker. Test may be made "in circuit" or out of circuit. Identifies and checks PNP and NPN types, plus power. Complete with instruction manual, service tips and transistor drawings.

Olson Electronics, Dept. 1U, 260 S. Forge St.,
Akron, Ohio 44308

I enclose \$12, plus \$1 for postage and handling. Send me the TE-199 Transistor Checker.

Send me the next seven issues of the Olson Catalog, without cost or obligation. **FREE**

Name _____

Address _____

City _____

State _____ Zip _____

CIRCLE NO. 20 ON READER SERVICE CARD

WANTED

THE RARE OR UNUSUAL TOOL YOU HAVE BEEN SEARCHING FOR

24 HOUR
DELIVERY ON
MOST ITEMS

SPECIALISTS
IN TOOLS FOR
INTEGRATED
CIRCUITRY

MORE THAN
5000 ITEMS

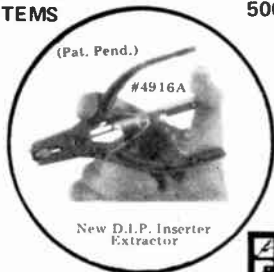

FREE 1971
(160 Page)
CATALOG AND SUPPLEMENT

TECHNI-TOOL, INC.

1218 ARCH ST., PHILA., PENNA.

ZIP CODE: 19107-(215) LO 8-4457

CIRCLE NO. 28 ON READER SERVICE CARD



KITS FEATURED IN
**POPULAR
ELECTRONICS**
AND FROM OTHER SOURCES

Psychedelic Strobe Light	\$17.50
"UT" Stereo Amplifier	\$80.00
FET Preamp	\$44.50
SCA Adaptor	\$14.50
Ultrasonic Alarm	\$37.25
Regulated Power Supply	\$39.50

Prices plus postage and insurance

Also:
Psychedelia I Color Organ, Sorolite,
Nixie Readouts, Frequency Counters,
Sports Timers, Ultrasonic Alarm, etc.

WRITE FOR FREE CATALOG
Southwest Technical Products
219 (PE) W. Rhapsody
San Antonio, Texas 78216

CIRCLE NO. 26 ON READER SERVICE CARD

SOLID STATE

(Continued from page 95)

Power Plus!!! General Electric's Semiconductor Products Department (Auburn, N. Y.) has announced an SCR with the highest voltage rating in domestic production with the addition of its new C602. Utilizing an alloy diffused process, the C602 is rated at 2600 volts and 600 amperes average and is designed for phase control of high voltage dc motors and replacement of ac contactors in HV lines.

Recognizing the growing demand for components to build advanced visual displays, Motorola has just introduced a MOS integrated-circuit character generator. The device generates the voltage patterns needed to form numbers, letters, and symbols on visual displays such as LED arrays or CRT's. It is normally driven by address codes originating in a computer or other data source.

Designated the MCM1131L, the new column-select generator can supply 2 mA output current, thus eliminating the output transistor amplifiers normally required for interfacing to TTL logic in display systems.

The circuit consists of an address decoder, a 2240-bit read-only memory (ROM) matrix, column select logic, and output buffers. It is the specially programmed ROM which stores the commands needed to produce the 64 different standard US ASCH characters on the face of a CRT or LED dot matrix display. Each character is composed of a 5 x 7 bit matrix requiring 35 memory elements, while the total memory consists of 64 of these matrices.

Offered in a 24-pin dual-in-line package, the MCM1131L sells for \$22.00 each in small quantities.

Motorola has also announced the addition of two new devices to its recently introduced MECL 10,000 emitter-coupled logic series. The new units are the MC10110L, a dual 3-input/3-output OR gate, and the MC10111L, a dual 3-input/3-output NOR gate. Both devices are supplied in ceramic dual-in-line packages.

And still more! Motorola has added 167 new devices to the now-famous HEP line, making a grand total of 470 devices available to the electronics experimenter. The new devices include light-emitting diodes (LED's), phototransistors, a line of TTI logic, high-threshold IC's diode-transistor logic (DTL), and some new resistor-transistor logic items. In addition, the HEP line now includes the high-speed emitter-coupled logic (ECL), some new linear devices, UHF hot carrier diodes, and voltage-variable capacitance diodes. ◆

THE MOST SPECTACULAR SOUND EXHIBITION OF STEREO FIDELITY EVER AVAILABLE ON ONE DISC.

This record is the result of two years of intensive research in the sound libraries of several of the world's leading record companies. The Editors of Stereo Review have selected and edited those excerpts that best demonstrate each of the many aspects of the stereo reproduction of music. The record offers you a greater variety of sound than has ever before been included on a single disc.

AN ELECTRIFYING EXPERIENCE IN LISTENING

The Stereo Review Stereo Demonstration Record is a series of independent demonstrations, each designed to show off one or more aspects of musical sound and its reproduction. Entirely music, the Record has been edited to provide self-sufficient capsule presentations of an enormous variety of music arranged in a contrasting and pleasing order. It includes all the basic musical and acoustical sounds that you hear when you listen to records, isolated and pointed up to give you a basis for future critical listening.

WIDE RANGE OF DEMONSTRATIONS

• Techniques of Separation and Multiple Sound Sources • Acoustic Depth • The Ambiance of a Concert Hall • Sharp Contrasts of Dynamics • Crescendo and Diminuendo • Very High and Very Low Pitched Musical Sounds • Polyphony (two or more melodies going on at once) With Both Similar and Contrasting Instruments • Sounds of Wind, String and Percussion Instruments • Sounds of Ancient Instruments • Sounds of Oriental Instruments • Sound of the Singing Voice, Both Classically Trained and Untrained • Plus a Large Sampling of Finger Snapping, Hand Clapping, Foot Stamping and Other Musical and Percussive Sounds

13 SUPERB SELECTIONS

STRAUSS: Festive Prelude, Dp. 61 (excerpt) Deutsche Grammophon Gesellschaft • Scored for full symphony orchestra plus organ with prominence to the brass instruments. Remarkable for the impressive sense of depth it reproduces.

DEBUSSY: Faux d'artifice (excerpt), Connoisseur Society • Virtually the entire range of the piano is used, including the full force of the bass notes. This is the sound of a piano in reverberant surroundings heard fairly close-up.

BEETHOVEN: Wellington's Victory (Battle Victory) (excerpt from the first movement) Westminster • The recording emphasizes extreme directionality. It is a dramatic presentation engineered specifically for stereo reproduction.

MASSAIND: Canzona XXXV à 16 (complete) DGG Archive • Performed on old instruments, and recorded with techniques that combine directionality with depth and ambiance, this band reproduces the sound of the music in its original environment, a large and reverberant cathedral.

CORRETTE: Concerto Comique Dp. 8, No. 6, "Le Plaisir des Dames" (third movement) Connoisseur Society • Recording demonstrates the

Stereo Review **STEREO DEMONSTRATION RECORD**

A stunning series of demonstrations, each designed to show off one or more aspects of musical sound and its stereo reproduction.

sound and special layout of a small performing group (harpichord, cello and flutes) in fairly resonant surroundings.

KHAM: Raga Chandranandan (excerpt) Connoisseur Society • This classical Indian music provides some of the most exciting musical experiences imaginable. Directionality between vastly different instruments is the point here, as well as the sheer sound of the instruments themselves.

RDDRIGO: Concert—Serenade for Harp and Orchestra (excerpt from the first movement) Deutsche Grammophon Gesellschaft • This excerpt provides a wealth of instrumental color behind a harp solo. The music is clear, colorful, rather classical, and immensely entertaining.

MANITAS DE PLATA: Gypsy Rumba (complete) Connoisseur Society • The recording puts the listener in the center of a flamenco party by precisely transmitting the directionality, depth and ambiance of this completely impromptu recording session.

MARCELLO: (arr. King): Psalm XVII "The Heavens are Telling" (complete) Connoisseur Society • This arrangement of the brief Marcello Psalm is for brass, choir and organ, who answer one another antiphonally.

PRAETORIUS: Terpichore: La Bourée XXII (complete) DGG Archive • A musical gem played by a raft of renaissance instruments including recorders, viols, lutes, harpsichord, small kettle drums, chimes, bells, and triangle.

BERG: Wozzeck (excerpt from Act III) Deutsche Grammophon Gesellschaft • The acknowledged masterpiece of modern music incorporating the use of many unusual and extraordinary musical devices, including dramatic crescendos for full orchestra.

BARTOK: Sonata for two pianos and Percussion (excerpt from the first movement) Cambridge • The work is a stunning exploration of percussive sounds used as the basic material of the composition.

BEETHOVEN: Wellington's Victory (Battle Victory) (excerpt from the last movement) Westminster • A demonstration of one of stereo's greatest virtues, its unmatched ability to clarify separate contrapuntal voices being played by similar instruments.

Advanced New Anti-static Vinyl

Recorded with the cooperation of Deutsche Grammophon Gesellschaft, Connoisseur Society, Westminster Recording Company and Cambridge Records Incorporated, the Stereo Demonstration Record is processed and pressed on a newly developed, improved vinyl. It is permanently anti-static, repels dust and dirt and promotes longer stylus wear. The use of this material is conducive to low surface noise and contributes to the production of full dynamics and frequency range. The record continually looks new, sounds new and wears longer.

ORDER YOUR STEREO DEMONSTRATION RECORD OR CASSETTE TODAY

Record **\$5⁹⁸** Postpaid • Cassette **\$6⁹⁸** Postpaid

RECORDS • Ziff-Davis Service Division • 595 Broadway • New York, N.Y. 10012

My check (or money order) for _____ is enclosed. Please send the following:

_____ Stereo Review Stereo Demonstration Record Albums @ \$5.98 each postpaid.

Check one: 33½ RPM 45 RPM

_____ Stereo Review Stereo Demonstration Cassettes @ \$6.98 each postpaid.

(Outside U. S. A. please send \$8.00 for each record or cassette ordered.) New York State residents please include local sales tax. PE-9-71

Print name _____

Address _____

City _____ State _____ Zip _____

PAYMENT MUST BE ENCLOSED WITH ORDER

▶ FREE DESCRIPTIVE BOOKLET ENCLOSED WITH EACH ALBUM AND CASSETTE

Packed with valuable facts to give you a better understanding of the term "stereo high fidelity," including a discussion of the selections appearing on the record, plus a complete description of each selection performed and the purpose behind its demonstration.

▶ 12" STEREO RECORDING AVAILABLE IN YOUR CHOICE OF 33½ RPM OR 45 RPM

The 33½ rpm is of the highest attainable quality at that speed. The higher speed of the 45 enables an even higher quality disc.

TUNER SERVICE

VHF, UHF, FM or IF Modules . . .

. . . All Makes

Fast **8** hr. Service!



1 YEAR GUARANTEE

VHF-UHF-FM	\$ 9.95
UV-COMB.	\$16.95
IF-MODULE	\$12.50

Major Parts charged at Net Price
P.T.S. is overhauling more tuners for
more technicians than any other
tuner company in the world!

LIKE TO DO IT YOURSELF?

Send one Dollar (redeemable) for our
60 pages of top information

**TUNER REPLACEMENT GUIDE AND
PARTS CATALOG**

For fastest service, send faulty tuner with
tubes, shields and all broken parts to:

PTS ELECTRONICS, INC.

"Passion Tuner Service"



HOME OFFICE—
Box 272 • Bloomington, Ind. 47401 • Tel. 812-824-9331
WEST—
Box 41354 • Sacramento, Calif. 95841 • Tel. 916-482-6220
SOUTH—
Box 7332 • Longview, Tex. 75601 • Tel. 214-753-4334
SOUTHEAST—
Box 6881 • Jacksonville, Fla. 32205 • Tel. 904-389-9952
EAST—
Box 3189 • Springfield, Mass. 01103 • Tel. 413-734-2737
MOUNTAIN—
Box 4245 • Denver, Colo. 80204 • Tel. 303-244-2818

CIRCLE NO. 21 ON READER SERVICE CARD

Put it to Work!

**NEW AND ONLY
FROM EICO—
THE INDUSTRY'S
LOWEST-PRICED
PROFESSIONAL
FET-TVM.**

Model 239
\$39.95
KIT



Use the battery powered Solid State EICO 239 on your bench or in the field. Check semiconductor and vacuum tube circuits. 11 Megohm DC input impedance. Read AC rms and DC voltages in seven steps from 1 to 1000 volts on large 4½" meter. Measure and read peak-to-peak AC to 2800 volts. Check resistance from 0.2Ω to 1000MΩ on seven ranges. Provides a total of 28 useful ranges on 12 accurate scales. Automatic battery check. Includes exclusive DC/AC ohms Uniprobe™. Factory Assembled, \$59.95.

FREE 32 PAGE EICO CATALOG

For latest catalog on EICO Test Instruments, Stereo, EICOCRAFT Projects, Environmental Lighting, Burglar/Fire Alarm Systems, and name of nearest EICO Distributor, check Reader Service Card.

EICO, 283 Malta Street, Brooklyn, N.Y. 11207



CIRCLE NO. 14 ON READER SERVICE CARD

ALL AMERICAN

(Continued from page 41)

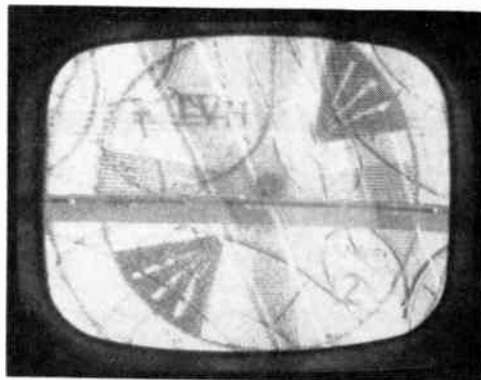

Actual reception (above) of KTVH, channel 12, Hutchinson, Kan. (155 miles) using only an outdoor antenna cut for that channel. Note severe adjacent channel interference from channel 13 (2.1 miles). Below is reception of channel 12 using the All American unit.

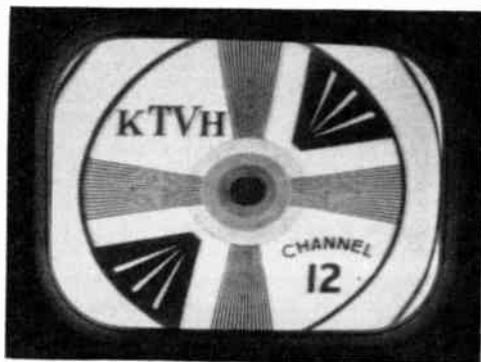

the interference from the adjacent channels.

Following the bandpass filter are three stages of FET amplifiers. Using the E-300, a plastic-case, low-cost version of the 2N5397, the three stages provide a total gain of 22 to 25 dB. The E-300's, in common-gate operation, have only a 1.3-dB noise figure at 100 MHz; at 216 MHz (channel 13) the figure is 2.0 dB. Additional bandpass filtering is provided in these stages by the etched inductors.

In the high-band (channels 7-13) of the All American, the same principle of operation is used. The bandpass filter, however, contains 11 sections and there are four stages of FET amplification. ♦

UNDERSTANDING SYSTEMS

(Continued from page 53)

much dispute—even among teachers—as to whether it is a science, a field of engineering, or a mixture of math, logic, art, and magic.

“Christmas-Tree” Approach. One type of concept understanding was exemplified by the famous “Christmas Tree” approach. At the top of the tree was a statement of the problem. The tree’s branches then consisted of procedural statements such as “if this happens, proceed to that” and “if this does not happen, proceed there.” In this way, signal flow was followed.

Since we do not have a Christmas tree diagram for every electronic device ever built, however, we must construct one in our mind each time we tackle a system—regardless of its complexity. This is the aim of concept understanding. Once the basic flow has been established mentally, a deviation from that flow (which we call improper operation) can be traced to its

origin. Obviously, this means that we must have a good knowledge of how the system is supposed to operate.

The idea of systems understanding is used in this magazine in nearly all of the articles involving digital integrated circuits. Logic diagrams are used to show the operation of the system rather than the extreme complexity of every detail within the IC’s. ♦

INTERFACE

(Continued from page 10)

The modulating audio signal, inserted in the low-impedance side of the transformer, is less than 0.2 watt and can be increased until negative peak voltages extinguish the discharge plasma.

Earnest A. Franke, WA4WDK/2
Matawan, N. J.

Strictly from the standpoint of the circuitry, the use of a modulating transformer would be simpler. However, the cost of such a transformer is in the \$15-plus range, while the cost of the tube and associated components and hardware is considerably less than \$5.

NEW DELUXE COLOR ORGAN CIRCUITS! UP TO 35,000 WATTS

A.P.M. SYSTEMS CORP., MANUFACTURERS OF THE FINEST
COLOR ORGANS IN THE WORLD, NOW OFFER YOU THE MOST
ADVANCED AND POWERFUL COLOR ORGAN CIRCUITS.

AVAILABLE IN 3 AND 4 CHANNEL KITS FEATURING:

- Solid State (easy to assemble printed circuit).
- All UL listed components.
- 3 channel circuit - 2,670 watts - easily converted to handle up to 26,250 watts.
- 4 channel circuit - 3,556 watts - easily converted to handle up to 35,000 watts.
- Electronically balanced circuitry permits one step tuning.
- Wires to any popular sound system in the same manner as a speaker.
- 2 year unconditional guarantee on all parts.
- Easy to assemble kit form.

SEND TODAY

FREE color brochure
with each kit order.

A.P.M. SYSTEMS, INC.
1551 Almaden Rd.
San Jose, Calif. 95125

PLEASE RUSH ME MY A.P.M. COLOR ORGAN KIT, AS INDICATED BELOW:

Check box to indicate choice.

- 3 Channel Kit - \$37.95
 4 Channel Kit - \$54.95
 3 Channel Plans - 26,250 watts - \$2.00
 4 Channel Plans - 35,000 watts - \$2.00
 Color brochure on water swirls and living walls - \$.50

Check one box to indicate manner of payment.

- I enclose full payment. Ship kit postpaid.
 I enclose \$5.00 deposit. Ship kit C.O.D. for balance plus postage.

Name _____

California residents add 5% sales tax

Address _____

City & State _____ Zip _____

A.P.M. SYSTEMS, INC. Dept. M15
P.O. Box 9159, San Jose, Calif. 95117

NEW PRODUCTS (CONTINUED FROM PAGE 24)

REGENCY SIGNAL-SEEKING RADIO—A new three-band FM Monitorradio/Executive Scanner will be the top-of-the-line feature for Regency Electronics, Inc. Modular solid-state circuitry enables the receiver to automatically monitor up to 16 frequencies in the police, fire, public service, marine, and business area of the UHF and high and low VHF bands. It is claimed that the new scanner will perform monitoring functions that formerly required as many as three separate receivers. A handsome front panel features read-out scanning lights with corresponding pushbutton control for any combination of frequencies in the 30-50, 148-174, and 450-475 MHz bands. The push-button switches allow the operator to activate or deactivate quickly any of the channels within any of the three bands.

Circle No. 87 on Reader Service Card on Back Cover

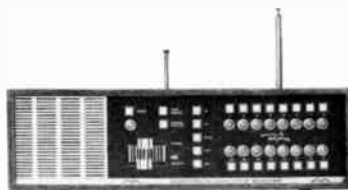

TDK "MAVERICK" CASSETTES—Despite their low cost the "Maverick" line of economy cassettes made by TDK Electronics Corp. are said to maintain the TDK tradition of high quality and guaranteed reliability. Three models are available: the C-30F (30 min), C-60F (60 min), and C-90F (90 min). The tape used in the cassettes is TDK's standard quality, offering broad frequency range and lower noise than many tapes designated as premium quality. Features include liners, stainless-steel pins, flanged rollers, see-through shock-resistant case, and a spring-loaded felt pressure pad.

Circle No. 88 on Reader Service Card on Back Cover

AMPEX 4-CHANNEL STEREO PLAYER SYSTEM—The Model 8400 is a 4-channel player with an AM/stereo FM receiver made by the Ampex Corp. It features a discrete 4-channel tape player, four preamplifiers, and two power amplifiers. Two speakers are included in the system. The 8400 will play regular two-channel stereo as well as four-channel material simply by adding another pair of speakers. Output power is rated at 20 watts. Price is less than \$230.00.

Circle No. 89 on Reader Service Card on Back Cover



VACO 18"-LONG NUT DRIVERS—Two super long nut drivers have just been introduced by Vaco Products Co. They are available in two sizes: $\frac{3}{4}$ " (No. S-818) and $\frac{7}{16}$ "



DRAKE
MODEL
SPR-4
\$499⁹⁵
NET

COMMUNICATIONS RECEIVER

A general purpose receiver, the SPR-4 may be programmed to suit any interest: SWL, Amateur, Laboratory, Broadcast, Marine Radio, etc. Frequency Coverage: 150-500 KHz plus any (23) 500 KHz ranges, 500 to 30 MHz.

FEATURES: ● Linear dial with 1 KHz readout ● 4-pole crystal filter in first IF ● 4-pole LC filter in second IF ● Three bandwidths: 0.4 KHz, 2.4 KHz, and 4.8 KHz for: CW, SSB, AM ● Superior cross-modulation and overload performance ● Power: 120 VAC, 220 VAC, and 12 VDC ● Crystals supplied for LW, BC and seven SW bands ● Built-in speaker ● Notch Filter.

ACCESSORIES: 100 KHz calibrator, noise blanker, transceiver adapter (T-4XB), DC power cord, loop antenna, crystals for other ranges.

- Direct Frequency Dialing ● All Solid State
- Programmable Coverage ● FET Circuitry

For more details write: **R. L. DRAKE COMPANY** 540 Richard St., Miamisburg, Ohio 45342

CIRCLE NO. 13 ON READER SERVICE CARD

(No. S-1018) hex sockets. The drivers extend 18" out of the handle for use in servicing deepset hex nuts and bolts in all areas of electronics. The drivers have hollow shafts, extra-hard tempered sockets, and large break-proof/shock-proof "Comfordome" handles. Each lists for \$4.80.

Circle No. 90 on Reader Service Card on Back Cover

TEAC SUPERIOR-SOUND/LOW-NOISE TAPE DECK—Teac Corp. of America has designed a tape deck (Model 4010SL) fully capable of utilizing the superior performance characteristics of the new "low-noise/high-output" magnetic tapes. This is accomplished through a new design concept in which background noise and hiss are reduced to levels below audibility, thus providing a new tonal clarity of highs not previously possible. Dynamic range is also extended, making possible the full enjoyment of lower listening levels free of annoying tape coloration. Price \$499.50.

Circle No. 91 on Reader Service Card on Back Cover

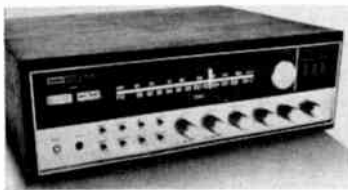

HARMAN-KARDON AM/STEREO FM RECEIVER—Breaking new ground in the hi-fi industry, the Harman-Kardon Model 390 hi-fi receiver incorporates two totally separate power supplies to assure flawless performance regardless of how much power the amplifier is called on to deliver. Each channel has its own regulated voltages to permit response to full rms output power without being affected by the other channel. Under such circumstances, recovery time of the 930 is virtually instantaneous. Output power is rated at 60 watts/channel with both channels driver simultaneously at 1000 Hz. Price \$369.95.

Circle No. 92 on Reader Service Card on Back Cover

WELLER PROFESSIONAL DESOLDERING TOOL—Easy desoldering of components from printed circuit boards or conventional circuits without damage to the component or the circuit board is accomplished with the Model DS-40 Professional Desoldering Tool from Weller. Heated solder is sucked up through a hollow tip in the tool through the vacuum created by a rubber bulb. The versatile tool can also be used for resoldering operations.

Circle No. 93 on Reader Service Card on Back Cover

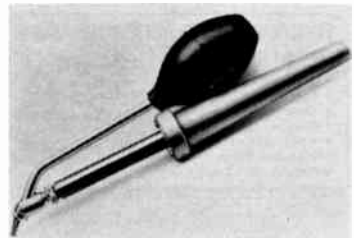

FREE McIntosh CATALOG and FM DIRECTORY

Get all the newest and latest information on the new McIntosh Solid State equipment in the McIntosh catalog. In addition you will receive an FM station directory that covers all of North America.



MX 114

FM/FM STEREO TUNER
and STEREO PREAMPLIFIER

CIRCLE NO. 19 ON READER SERVICE CARD

SEND TODAY!

McIntosh Laboratory Inc.
2 Chambers St., Dept. PT-971
Binghamton, N.Y. 13903

NAME _____

ADDRESS _____

CITY _____ STATE _____ ZIP _____

ELECTRONICS MARKET PLACE

NON-DISPLAY CLASSIFIED: COMMERCIAL RATE: For firms or individuals offering commercial products or services, \$1.25 per word (including name and address). Minimum order \$12.50. Payment must accompany copy except when ads are placed by accredited advertising agencies. Frequency discount: 5% for 6 months; 10% for 12 months paid in advance. **READER RATE:** For individuals with a personal item to buy or sell, 80¢ per word (including name and address). No Minimum! Payment must accompany copy.

DISPLAY CLASSIFIED: 1" by 1 column (25/8" wide), \$110.00. 2" by 1 column, \$215.00. 3" by 1 column, \$320.00. Advertiser to supply cuts.

GENERAL INFORMATION: First word in all ads set in bold caps at no extra charge. All copy subject to publisher's approval. Closing Date: 1st of the 2nd month preceding cover date (for example, March issue closes January 1st). Send order and remittance to Hal Cymes, POPULAR ELECTRONICS, One Park Avenue, New York, New York 10016.

FOR SALE

FREE! bargain catalog. Fiber optics, LED's, transistors, diodes, rectifiers, SCR's, triacs, parts. Poly Paks, Box 942, Lynnfield, Mass. 01940.

GOVERNMENT Surplus Receivers, Transmitters, Snooperscopes, Radios, Parts, Picture Catalog 25¢. Meshna, Nahant, Mass. 01908.

ROCKETS: Ideal for miniature transmitter tests. New illustrated catalog. 25¢. Single and multistage kits, cones, engines, launchers, trackers, rocket aerial cameras, technical information. Fast service. Estes Industries, Dept. 18-J, Penrose, Colorado 81240.

LOWEST Prices Electronic Parts. Confidential Catalog Free. KNAPP, 3174 8TH Ave. S.W., Largo, Fla. 33540.

WE SELL CONSTRUCTION PLANS. TELEPHONE: Answering Machine, Speakerphone, Carphone, Phonevision, Legal Connector, Auto Dialer, Central Dial System. **TELEVISION:** \$35.00 Color Converter, Tape Recorder, 3DTV. \$25.00 Camera. **HOBBYIST:** Electron Microscope, 96 Hour Tape Music System, Ultrasonic Dishwasher, Radar-Oven, Electronic Tranquilizer. Plans \$4.95 each. **COURSES:** Telephone Engineering \$39.50. Detective Electronics \$22.50. Anti-Detective Electronics \$27.50. **NEW SUPER HOBBY CATALOG AIRMAILED \$1.00.** Don Britton Enterprises, 6200 Wilshire Blvd., Los Angeles, Calif. 90048.

FIND COINS-GOLD-RELIQS-TREASURE metal locators by JETCO!

- Lightweight
- Easy to Use
- Comes Complete
- Made in USA
- 5 yr. Guarantee
- Immediate Delivery!
- Write for FREE Catalog.

priced from **\$39.95**



JETCO ELECTRONIC INDUSTRIES, INC.
P. O. BOX 132, P.E. HUNTSVILLE, TEXAS 77340
PHONE ORDER TO: 713/295-9422

WEBBER LAB'S Police & Fire Converters. Catalog 25¢. 72 Cottage Street, Lynn, Mass. 01905.

INVESTIGATORS, latest Electronics Aids. Free Literature. Clifton, 11500-L NW 7th Ave., Miami, Florida 33168.

ELECTRONIC PARTS, semiconductors, kits. **FREE FLYER.** Large catalog \$1.00 deposit. BIGELOW ELECTRONICS, Bluffton, Ohio 45817.

RADIO—T.V. Tubes—36¢ each. Send for free catalog. Cornell, 4213 University, San Diego, Calif. 92105.

CLEARANCE SALE rectifiers, transistors, 1000's other items. Catalog 15¢. General Sales Company, 254 Main, Clute, Texas 77531.

MECHANICAL, ELECTRONIC devices catalog 10¢. Greatest Values—Lowest Prices. Fertik's, 5249 "D", Philadelphia, Pa. 19120.

SENCORE B&K Test Equipment Unbelievable Prices. Free Catalog and Price Sheet. Fordham Radio, 265 East 149th Street, Bronx, N.Y. 10451.

ELECTRONIC Ignition. Various Types. Information 10¢. Anderson Engineering, Epsom, N.H. 03239.

NEW SEMICONDUCTOR LIGHT EMITTING DIODES—bright red lights replace light bulbs. Typical life 100 years. Operate at 1.65 volts, 50 milliamps. Order 2 for \$2.98 NOW. Data sheet and instructions included. Monsanto Company, Hobby Section, 10131 Bubb Road, Cupertino, California 95014.

CONVERT any television to sensitive, big-screen oscilloscope. Only minor changes required. No electronic experience necessary. Illustrated plans, \$2.00. Relco-A33, Box 10563, Houston, Texas 77018.

SPACE-AGE TV CAMERA KITS & PLANS



BE A PIONEER IN HOME TELECASTING! Build your own TV CAMERA. Model XT-1A, Series D, \$116.95 pp. Solid-State. Step-by-step construction manual. High quality. Connects to any TV without modification. Ideal for home, experimenters, education, industry, etc.

PHONE or WRITE for CATALOG.
DIAL 402-985-3771

Many other kits, parts and plans available including starter kits, focus/drift, coils, vidicon tubes, const. plans, etc.

1301 N. BROADWAY ATV Research DAKOTA CITY, NEBR. 68731

ELECTRONIC COMPONENTS—Distributor prices, Free catalog. Box 2581, El Cajon, California 92021.

FREE Kit Catalog: Shortproof Powersupply \$39.50. Ultrasonic Alarm \$37.25. SWTPC, Box B32040, San Antonio, Tex. 78216.

AMATEUR SCIENTISTS, Electronics Hobbyists, Experimenters, Students . . . Construction Plans—all complete, including drawings, schematics, parts lists with prices and sources . . . **Radar—**Build your own ultrasonic doppler radar. Detect motion of people, automobiles, even falling rain drops. Transistorized, uses 9 volt transistor battery—\$4.50 . . . **Long-Range "Sound Telescope"**—This amazing device can enable you to hear conversations, birds and animals, other sounds hundreds of feet away. Very directional. Transistorized. Uses 9V battery—\$3.50 . . . **Robot Man—**Moves hands and arms—\$3.50 . . . Or send 25¢ coin (no stamps) for complete catalog. Other items include Psychedelic strobes, light shows, lasers . . . 46 different projects. Technical Writers Group, Box 5994, State College Station, Raleigh, N.C. 27607.

DEALERS WANTED! Citizens Band, AM, SSB, Two-way Radios & Accessories. USA and Export models. We ship around the world. Send letterhead to: Baggy's Radio P.O. Box 778, 6391 Westminster Ave., Westminster, Ca. 92683. 714-894-3301.

CITIZENS BAND-Shortwave Listener-Ham equipment from Amrad Supply, Inc. Free Flyer, 1025 Harrison St., Oakland, Calif. 94607.

PSYCHEDELIC Strobe Kit: Complete with 110w/sec. tube, reflector, chassis and cabinet \$17.50 plus postage and insurance, 2 lbs. (Extra tubes \$3.50) SWTPC, Box E32040, San Antonio, Texas 78216.

SEMICONDUCTORS: Buy from single source. Serving experimenters, hobbyists. No minimums. SN 7400N, 1.95; MC724P, \$1.19, Etc. RLabs, Box 253, Burlington, Ma. 01803.

ANTIGRAVITY, experiment and theory; Rushed—\$2.00. U.S. Inquiries. Intertech 7A12, Box 5373, Station-F, Ottawa, Canada.

LEARN the facts of electronics and your privacy. Send for the Iron-X Manual, P.O. Box 38155, Hollywood, CA 90038. \$5.95.

JAPAN HONG KONG DIRECTORY. World products information. \$1.00 today. Sekai Shogyo Annai, Hillyard, Washington 99207.

INTEGRATED CIRCUITS—Factory Prices, Catalog 10¢. Silling, Box 6257, Seattle, Washington 98188.

DEALERS WANTED!

CITIZENS BAND, AM, SSB, Two-way Radios & Accessories. USA and export models. We ship around the world. Send letterhead to:

BAGGY'S RADIO

P.O. Box 778, 6391 Westminster Ave.,
Westminster, California 92683
714-894-3301

FREE Kit Catalog: Color Organs \$11.00, Psychedelic Strobes \$17.50, Professional quality—lowest prices. SWTPC, Box F32040, San Antonio, Texas 78216.

EUROPEAN and Japanese bargains catalogs. \$1 each. Dee, P.O. Box 9308, North Hollywood, Calif. 91609.

BURGLAR ALARM SYSTEMS. We manufacture intruder-fire detection systems, radar and perimeter types. Accessories available. Free Literature. Inquiries for dealership and wholesale prices must be on letterhead. U.S. and Canada only. Microtech Associates, Inc., Box 10147, St. Petersburg, Florida 33733.



BARGAIN HUNTING?

SEND 10¢ TO DEPT 6
FOR BARGAIN CB CATALOG!

HENSHAW'S

3617 TROOST, KANSAS CITY, MO

BRAINWAVES—BIOFEEDBACK products, literature. Meditation aids. Innerspace, Box 319-PE, Fairfax, CA 94930.

"LISTEN IN" TO POLICE-FIRE RADIO CALLS IN YOUR CAR!

WORKS WITH ANY CAR—Portable or HOME RADIO! Just PLUGS in—No wiring—3 minute hook-up! Switch instantly from regular to ALL POLICE-FIRE-EMERGENCY-COMMERCIAL-TAXICAB-STATE-CITY-GOV'T 2 way Radio calls in YOUR AREA. DUAL-HI-LOW BANDS—OVER A MILLION Radio Cars-nations. USE Everywhere—anytime—always works!

SEND ONLY \$2.00 (cash, Ck., M.O.) and pay post-mail \$7.99 plus C.O.D. post & send \$9.99 for ppd Del in USA. COMPLETE, ready to use with instructions. One Year service Warranty—10 DAY MONEY BACK TRIAL (if retnd). AMAZING OFFER good only by mail—WESTERN RADIO Dept. SPE-9 KEARNEY, NEBR. 68847



CONSTRUCTION PLANS: Laser . . . \$2.00. Investigation Aids—2-FM Microphone Transmitters . . . \$1.00. FM Telephone Transmitter . . . \$2.00. Sound Telescope . . . \$2.00. Space Monitor—Missile Tracker . . . \$2.00. Free equipment and kit catalog. Howard, 20174 Ward, Detroit, Michigan 48235.

GERMAN AND JAPANESE tubes, transistors, and parts price list \$1.00. Matthews TV, 1413 Lee, Lawton, Oklahoma 73501.

duo-band • auto search Monitor Receiver



pei 8-channel scanning monitor HL-44 locks on active channel,

then resumes search when channel goes quiet. Program scanning speed, any number of high or low band channels by plugging in crystals. NO WIRING CHANGES. Use it on your desk or in your car.



Write for free literature.

PETERSEN ELECTRONICS, INC.

1000 South Main— Council Bluffs, Iowa 51501

FREE! 1972 Electronics Catalog. McCord Electronics, Box 41-P, Vanlandia, Ohio 43650.

STOP: Misc. electronic items. Flyer 10¢. Jerry Crossno, Box 266, Norris, Tenn. 37828.

POWER your bicycle electrically using storage battery. Illustrated plans \$3.00. AEE, Box 292, Minneapolis, Minn. 55440.

X-RAY device under \$20. Plans \$1.50. Mitan, Box 24472, Los Angeles, California 90024.

USED Equipment, RCA, Tektronix, etc. Free list. Techsystems, Box 2421, Allentown, Pa. 18001.

PROFESSIONAL sustained fuzz unit, only \$29.95! Satisfaction guaranteed. E.J.L. Manufacturing, 1491 Overlook, Alliance, Ohio 44601.

ALL BAND TRAP ANTENNA!



Reduces Noise on All Makes Short Wave Receivers. Makes World-Wide Reception Better. Complete with 96 ft. 72 ohm

feeding. Sealed resonant traps. For novice and all class radio amateurs! Eliminates 2 separate antennas with excellent performance on all 80-40-20-15-10 meter bands. Complete 102 ft. \$19.95. 40-20-15-10 meter bands. 54 ft. (best for world-wide short wave reception) \$18.95. send only \$3.00 (cash, ck., mo) and pay postman balance COD plus postage on arrival or send full price for post-paid delivery. Complete instructions included.

WESTERN ELECTRONICS Dept. E-9 Kearney, Nebraska 68847

CAPACITIVE Discharge Ignition Systems by Delta at discount prices. Write Southland Communications, P.O. Box 3591, Baytown, Texas 77520.

POLICE-FIRE Radio dispatcher callbooks! Exclusive official listings. Callsigns, frequencies! Nationwide. Send 8¢ stamp for catalog. Communications, Box 56-PE, Comack, N.Y.

TELEPHONES . . . Modern, Continental, components. Free brochure. Comet Communications Co., Dept-B, 639 50th St., Brooklyn, New York 11220.

BRAINWAVE Feedback. Electroencephalophone teaches alpha-wave control. J&J Enterprises, 8102-E, Bainbridge, Wash. 98110.

HOW to break into radio, television broadcasting. Book \$2.69. I. Q. Engineering, Box 374, Canoga Park, California 91304.

TREMBRATO! Shimmering, moving sound effects for your organ or guitar will give it more versatility, economically. Write to: Musicon Electronics Co., Box 59, Ft. Washington, Pa. 19034.

PULSE Generators, oscillators, logic modules, booklets, and plans. Free literature. Scientific Measurements, 2945 Central, Wilmette, Illinois 60091.

110 VOLTS from your car's alternator! Build adapter for \$3.00! Complete construction plans \$5.00, plus free color catalog. Creative Products, 1708 Tierney Road, Fort Worth, Texas 76112.

UNIQUE catalog of Electronic devices, modules, and components including many schematics. Send 25¢ to Chaney, Box 133, Tempe, Ariz. 85281.

INVESTIGATORS—Detectives—Industrial security officers. Latest subminiature electronic equipment. Catalog 50¢. Jack, Box 19422, Sacramento, Calif. 95819.

RELAY, integrated circuit size, \$1.00. Operate by transistor or IC; for alarms, controls a communication equipment Kam, 845 Commercial Street, San Jose, Calif. 95112.

FREE ELECTRONICS Catalog. Tremendous bargains. Edu-Kits, Department C-705 D, Hewlett, New York 11557.

TV TUNER REPAIRS—Complete Course Details, 12 Repair Tricks, Many Plans, Two Lessons, all for \$1. Refundable. Frank Bocek, Box 833, Redding, Calif. 96001.

PLANS AND KITS

FREE Kit Catalog: Digital Microlab \$29.95. Also Segmented and Nixie Readouts, Timebases, Scalers, Electronic Digital Clocks (all featured in Popular Electronics) SWTPC, Box C32040, San Antonio, Tex. 78216.

COLOR Organs, strobes. Big savings, plans brochure 10¢. RAECO Box 14, Readville, Mass. 02187.

AUTOMATIC Morse Code Copying Machine. Featured in Ham Radio Magazine this fall. Copy up to 120 wpm without knowing CW! Simply hook to your receiver's audio and read printout. Send \$14.95 for detailed construction plans. VMG Electronics, 2138P West Sunnyside, Phoenix, Arizona 85029.

FREE kit Catalog: Amazing new Universal Digital Instruments with plugins as featured in **Popular Electronics**. Unbeatable prices. SWTPC, Box D32040, San Antonio, Tex. 78216.

STOP Thief! Burglar alarm acts before entry. Plans \$2.00. Millers, 1896 Maywood, S. Euclid, Ohio 44121.

TICTACTOE Playing Electronic Device: Never loses. Inexpensively built. Plans \$2.00. Jebco Enterprises, Box 3034, Hollywood, California 90028.

FREE Kit Catalog. Why does every major College, University, Technical School, Research & Development Center buy from us? Because we have the highest quality and lowest prices. Free catalog. SWTPC, Box H32040, San Antonio, Tex. 78216.

PLANS AND KITS

HOBBYISTS—Programmable electronic combination lock kit. Five IC's, plans, theory, \$5.95. Catalog free. John Huntley, 1351 Mahoney, Rodeo, Calif. 94572.

ELECTRIC BICYCLE. Ride all day for nickel. Complete plans \$3.00. Electro, Box 27203-E, Indpls., Ind. 46227.

HIGH FIDELITY

TAPE RECORDERS, Hi-Fi, components, Sleep Learning Equipment, tapes. Unusual Values. Free Catalog. Dressner, 1523R, Jericho Turnpike, New Hyde Park, N.Y. 11040.

LDW, Low quotes: all components and recorders, HiFi, Roslyn, Penna. 19001.

FREE Kit Catalog. Amplifiers: Lil Tiger \$11.10, Universal Tiger \$30.00, Preamp \$44.50 (Featured in **Popular Electronics**) SCA Adaptors \$14.55. SWTPC, Box A32040, San Antonio, Tex. 78216.

DIAMOND NEEDLES and Stereo Cartridges at Discount prices for Shure, Pickering, Stanton, Empire, Grado and ADC. Send for free catalog. All merchandise brand new and factory sealed. LYLE CARTRIDGES, Dept. P, P.O. Box 69, Kensington Station, Brooklyn, New York 11218.

WANTED

CASH PAID! Unused tubes, electronic equipment. Barry, 512 Broadway, NYC 10012.

QUICKSILVER, Platinum, Silver, Gold, Ores Analyzed. Free Circular. Mercury Terminal, Norwood, Mass. 02062.

TUBES

TUBES "Oldies", latest. Lists free. Steinmetz, 7519 Maplewood, Hammond, Indiana 46324.

RECEIVING & INDUSTRIAL TUBES, TRANSISTORS, All Brands—Biggest Discounts. Technicians, Hobbyists, Experimenters—Request **FREE Giant Catalog and SAVE! ZALYTRON,** 469 Jericho Turnpike, Mineola, N.Y. 11501.

RADIO & T.V. Tubes—36¢ each. Send for free catalog. Cornell, 4213 University, San Diego, Calif. 92105.

TUBE Headquarters of World! Send 10¢ for Catalog (tubes, electronic equipment) Barry, 512 Broadway, N.Y.C. 10012.

SAVE money on parts and transmitting-receiving tubes, foreign-domestic. Send 25¢ for giant catalog. Refunded first order. United Radio Company, 56-P Ferry Street, Newark, N.J. 07105.

REPAIRS AND SERVICES

TV Tuners rebuilt and aligned per manufacturers specification. Only \$9.50. Any make UHF or VHF Ninety day written guarantee. Ship complete with tubes or write for free mailing kit and dealer brochure. JW Electronics, Box 51C, Bloomington, Indiana 47401.

TAPE AND RECORDERS

OLD radio programs on tape. 6 hours for \$8.00. Catalog 50¢. Don Maris, 1926 Cherokee, Norman, Okla. 73069.

STEREO TAPE RENTAL for particular people. Free catalog. Gold Coast Tape Library, Box 2262, Palm Village Station, Hialeah, Fla. 33012.

STEREO TAPE TRANSPORT—7" reel—2 speeds—pause control—made for famous manufacturer—50 to 15,000 Hz—with rec/play and erase heads, without case. Send m.o. or check for \$19.50 to Alseimer Audio Electronics, 218 Columbia St., Utica, N.Y. 13502. \$2.50 for prepaid shipping and insurance.

RENT 4-Track open reel tapes—all major labels—3,000 different—free brochure. Stereo-Parti, 55 St. James Drive, Santa Rosa, Ca. 95401.

BARGAIN MUSIC, Tape, Equipment Catalog, 25¢. Saxitone, 1776 Columbia Road, Washington, D.C. 20009.

RECORDING TAPE made by top American manufacturer, guaranteed not "seconds" or "white box"; 2400' mylar, \$2.29; 1800' mylar \$1.69; 1200' acetate \$.79. Send for information and quantity pricing. Alseimer Audio Electronics, 218 Columbia Street, Utica, New York 13502.

BUY Irish Tape Open Reel & Cassettes & 8-Track Blanks at Discount Prices. Write: Direct Mail Cassette Corp., Box 71, Plainview, N.Y. 11803.

GERMAN and Japanese tape recorders and stereos converted and repaired. Dual, Grundig, Sansui, Akai, Teac and others. Matthews T.V., 1413 Lee Blvd., Lawton, Okla. 73501.

PERSONALS

MAKE FRIENDS WORLDWIDE through international correspondence. Illustrated brochure free. Hermes, Berlin 11, Germany.

INVESTIGATORS, Latest Electronics Aids. Free Literature. Clifton, 11500-K NW 7th Ave., Miami, Florida 33168.

SECRET LOANS BY MAIL. Borrow \$100 to \$1500 for any good reason in absolute privacy. No interviews, no endorsers, no cosigners. Fast service. Write Dial Finance Co., Dept. J-593, 410 Kilpatrick Bldg., Omaha, Nebraska 68102.

INSTRUCTION

LEARN ELECTRONIC ORGAN SERVICING at home all makes including transistor. Experimental kit—trouble-shooting. Accredited NHSC, Free Booklet. NILES BRYANT SCHOOL, 3631 Stockton, Dept. A, Sacramento, Calif. 95820.

LEARN WHILE ASLEEP, Hypnotize! Strange catalog free. Auto-suggestion, Box 24-2D, Olympia, Washington 98501.

DEGREE in electronics Engineering earned mostly by correspondence. Free brochure. Dept. G-9, Grantham School of Engineering, 1505 N. Western Ave., Hollywood, California 90027.

WANT AN F.C.C. 1st CLASS LICENSE? WANT TO BECOME A DISC-JOCKEY? REI has a school near you VA approved. Call toll free: 1-800-237-2251 or write REI, 1336 Main St., Sarasota, Florida 33577, Florida Residents call: 813-955-6922.

HIGHLY effective home study courses in Electronics Engineering Technology and Electronics Engineering Mathematics. Earn your Degree. Write for Free Descriptive Literature. Cook's Institute of Electronics Engineering, (Dept. 15), P.O. Box 10634, Jackson, Miss. 39209. (Established 1945).

FREE brochure self-improvement books. Eldon McBrayer, 412 Arthur Street, Huntsville, Ala. 35805.

FCC RADIOTELEGRAPH LICENSE through tape recorded lessons. Radio License Training, 1060D Duncan, Manhattan Beach, Calif. 90266. Phone 379-4461.

EARN College degree at home. Many subjects, Ministerial Studies, High School Equivalency Diploma. Florida State Christian College. Post Office Box 1674, Fort Lauderdale, Florida 33302.

FCC TYPE EXAMS . . . Guaranteed to prepare you for FCC 3rd, 2nd, and 1st phone exams. 3rd class \$7.00, 2nd class \$12.00, 1st class \$16.00, complete package \$25.00. Due to demand, allow 3 weeks for mailing. Research Company, Box 22141, Tampa, Florida 33622.

BASIC Electronic problems solved, detailed explanation, \$4.95. Holmes, 6244 Oakland, St. Louis, Mo. 63139.

INSTRUCTION

F.C.C. EXAM: Complete L.P. record courses guaranteed to prepare you for 3rd class or Novice license exam. \$5.95 each. Climax Recording Studios, Inc. 680 N.W. 123rd Street, N. Miami, Florida 33168.

PROGRAMMING, learn Fortran at home. Box 14474, Philadelphia, Pa. 19115.

LEARN the Basic Operation of Radio-TV from station to home. Available on Cassette and 8-track Cartridge. Send \$4.95 to NNA, P.O. Box 721, Rye, New York 10580.

MEMORIZE STUDY: "1971 Test-Answers" for FCC First and Second Class License—plus—"Self-Study Ability Test." Proven! \$9.95. Satisfaction guaranteed. Command, Box 26348-P, San Francisco 94126.

AMATEUR Radio. Complete correspondence tape-recorded license courses. Amateur Radio License School, 12217 Santa Monica Blvd., Los Angeles, Calif. 90025.

GOVERNMENT SURPLUS

JEEPS Typically From \$53.90 . . . Trucks From \$78.40 . . . Boats. Typewriters, Airplanes, Multimeters, Oscilloscopes, Transceivers, Electronics Equipment. Wide Variety. Condition. 100,000 Bid Bargains Direct From Government Nationwide Complete Sales Directory and Surplus Catalog \$1.00. (Deductible First \$10.00 Order). Surplus Service, Box 820-J, Holland, Michigan 49423.

GOVERNMENT Surplus. How and Where to Buy in Your Area. Send \$1.00. Surplus Information Headquarters, Box 30177-PE, Washington, DC 20014.

MANUALS for surplus electronic equipment. List 25¢. Books, 4905 Roanne Drive, Washington, D.C. 20021.

RECORDS

POPULAR organ albums factory direct. Concert Recording, Lynwood, Calif. 90262.

SPORTS ACTION FILMS

SHOWTIME AT HOME—Order 25¢ Catalog . . . and select your favorite Sports for Instant Replay. Super 8/8, Color. **SPORTLITE**, Elect. Dept., 20 North Wacker Drive, Chicago 60606.

INVENTIONS WANTED

INVENTIONS wanted. Patented; unpatented. Global Marketing Service, 2420-P 77th, Oakland, Calif. 94605.

PATENT Searches including Maximum speed, full airmail report and closest patent copies, \$6.00. Quality searches expertly administered. Complete secrecy guaranteed. Free Invention Protection forms and "Patent Information," Write Dept. 9, Washington Patent Office Search Bureau, 711 14th Street, N.W., Washington, D.C. 20005.

INVENTORS! Don't sell your invention, patented or unpatented, until you receive our offer. Eagle Development Company, Dept. 9, 79 Wall Street, N.Y., N.Y. 10005.

FREE "Directory of 500 Corporations Seeking New Products." For information regarding development, sale, licensing of your patented/unpatented invention. Write: Raymond Lee Organization, 230-GR Park Avenue, New York City 10017.

INVENTORS: Protect your ideas! Free "Recommended Procedure". Washington Inventors Service, 422T Washington Building, Washington, D.C. 20005.

FREE PAMPHLET: "Tips on Safeguarding Your Invention." Write: United States Inventors Service Company, 501-H Thirteenth Street N.W., Washington, D.C. 20004.

BOOKS

FREE catalog aviation/electronic/space books. Aero Publishers, 329PE Aviation Road, Fallbrook, California 92028.

FREE book prophet Elijah coming before Christ. Wonderful bible evidence. Megiddo Mission, Dept. 64, 481 Thurston Rd., Rochester, N.Y. 14619.

CLASSIFIED ADVERTISING ORDER FORM

Please refer to heading on first page of this section for complete data concerning terms, frequency discounts, closing dates, etc.

1	2	3	4	5
6	7	8	9	10
11	12	13	14	15
16	17	18	19	20
21	22	23	24	25
26	27	28	29	30
31	32	33	34	35

_____ Words { @ 80¢ (Reader Rate) } = \$ _____
 { @ \$1.25 (Commercial Rate) }

Insert _____ time(s) Total Enclosed \$ _____

NAME _____

ADDRESS _____

CITY _____ STATE _____ ZIP _____

Signature _____

WORD COUNT: Include name and address. Name of city (Des Moines) or of state (New York) counts as one word each. Zip Code numbers not counted. (Publisher reserves right to omit Zip Code if space does not permit.) Count each abbreviation, initial, single figure or group of figures or letters as a word. Symbols such as 35mm, COD, PO, AC, etc., count as one word. Hyphenated words count as two words.

PE971

MAGAZINES

JAPAN PUBLICATIONS GUIDE Business, pleasure, education. \$8.00. INTERCONTINENTAL, CPO 1717, Tokyo 100-91.

OVER 2,000,000 backdate magazines! Specify needs. Midtown, Box 917-PE, Maywood, New Jersey 07607.

FOR SALE Russian language "Radio" magazine. 50 different issues 1964-1970. First \$20. Gilfer, Box 239, Park Ridge, N.J. 07656.

HYPNOTISM

"MALE-FEMALE Hypnotism" Exposed, Explained! "Secret Method" —They Never Know! \$2. Rushed. Guaranteed! Isabella Hall, Silver Springs, Florida 32688.

SLEEP learning. Hypnotic method, 92% effective. Details free. ASR Foundation, Box 7021PE HC Station, Lexington, Ky. 40502.

MAGNETS

MAGNETS. All types. Specials—20 disc magnets, or 2 stick magnets, or 10 small bar magnets, or 8 assorted magnets, \$1.00. Maryland Magnet Company, Box 192H, Randallstown, Maryland 21133.

PHOTOGRAPHY—FILM, EQUIPMENT, SERVICES

SCIENCE Bargains Request Free Giant Catalog "CJ"—148 pages—Astronomical Telescopes, Microscopes, Lenses, Binoculars, Kits, Parts. War surplus bargains. Edmund Scientific Co., 300 Edscorp Bldg., Barrington, New Jersey 08007.

RUBBER STAMPS

RUBBER Address Stamps \$2.00. Signature \$3.50. Free Catalog. Jackson's, Box 443-G, Franklin Park, Illinois 60131.

STAMPS

FREE! 88 DIFFERENT COUNTRIES!! An Incredible Collection of genuine postage stamps . . . from Afghanistan to Zambia, all around the world! Stamps from the North and South Poles. British, French, Portuguese, Spanish Colonies. Ancient Stamps, New Issues, Airmails, Commemoratives, Moon and Outer Space Stamps—from 88 Countries! Also, other exciting stamps for free examination. Buy any or none, return balance, cancel privilege any time. Plus Big Introductory Catalog. Send 10¢ for mailing. H.E. Harris, Dept. SS-12, Boston, Mass. 02117.

EMPLOYMENT INFORMATION

EXCITING Overseas jobs. Directory \$1.00. Research Associates, Box 942-E, Belmont, California 94002.

BUSINESS OPPORTUNITIES

I MADE \$40,000.00 Year by Mailorder! Helped others make money! Start with \$10.00—Free Proof. Torrey, Box 318-N, Ypsilanti, Michigan 48197.

FREE BOOK "999 Successful Little Known Businesses" Work home, Plymouth 445-J, Brooklyn, N.Y. 11216.

\$200.00 DAILY In Your Mailbox! Your opportunity to do what mail-order experts do. Free details. Associates, Box 136-J, Holland, Michigan 49423.

FREE CATALOGS. Repair air conditioning, refrigeration. Tools, supplies, full instructions. Doolin, 2016 Canton, Dallas, Texas 75201.

MAILORDER! Make big money working home. Free report reveals millionaire's trade secrets! Executive (1K9), 333 North Michigan, Chicago 60601.

PIANO TUNING learned quickly at home. Tremendous field! Musical knowledge unnecessary. GI Approved. Information Free. Empire School, Box 327, Miami, Florida 33145.

SELL HERTEL BIBLES—Part Time. Finest reference Bible available. Demonstrator and supplies furnished. Excellent commissions. Write International Book, Dept. PE, Box 118, Wichita, Kansas 67201.

MONEY making opportunity electronic income tax return preparation. Free information. Exclusive territories. 34-I Brooks Tower, Denver, Colorado 80202.

MAIL GALORE! Money-making opportunities! Name on nationwide mailing lists, 35¢. Three months, 50¢. Sullins, Box 206-PE, Forsyth, Georgia 31029.

MAILORDER MONEYMAKING KIT. Home Business. Valuable lists, concrete information, detailed steps. Capital unnecessary. Free Details, pictures. Prudential, Box 327-PE9, Boston, Mass. 02199.

TWELVE Sensational money makers. Inexpensive Fire, Burglar Alarms, Extinguishers, Locks. Special Offer. Watchdog Marketing, Williamsburg, Ohio 45176.

TREASURE FINDERS

GOLD, Silver, Relics! Located with powerful Detectron Metal Detectors. Free Information. Terms, Detectron, Dept. PE9, Box 243, San Gabriel, California 91778.

TREASURE FINDER locates buried gold, silver, coins, treasures. 5 powerful models. \$19.95 up. Free catalog. Relco-A33, Box 10839, Houston, Texas 77018.

FREE: Jetco Electronics Free 24 page Treasure Finder catalog. Find metals, minerals, gold, silver, coins and relics, Jetco, Box 132 PE, Huntsville, Texas 77340.

FISHER DETECTORS has something new! Free literature. Fisher Research, Dept. PE-9, Palo Alto, CA 94303.

MUSICAL INSTRUMENTS

30% DISCOUNT name brand musical instruments. Free catalog. Freeport Music, 127-N Sunrise Highway, Freeport, N.Y. 11520.

WHOLESALE! Professional Amplifiers, PA Systems, Guitars. Free Catalog. Carvin, Escondido, Calif. 92028.

DO-IT-YOURSELF

BURGLARY-Fire Protection. Free Catalog. (Comprehensive Installation Manual loaned Free upon request). Safeway, 92A Brighton 11th Street, Brooklyn, New York 11235.

REAL ESTATE

FREE . . . NEW 240-Page FALL CATALOG! Describes and pictures hundreds of farms, ranches, town and country homes, businesses coast to coast! Specify type property and location preferred. Zip Code, please. United Farm Agency, 612-EP West 47th St., Kansas City, Mo. 64112.

AUTHORS' SERVICES

AUTHORS! Learn how to have your book published, promoted, distributed. FREE booklet "ZD," Vantage, 516 West 34 St., New York 10001.

MISCELLANEOUS

WINEMAKERS: Free illustrated catalog yeasts, equipment. Simplex, Box 12276, Minneapolis, Minn. 55412.

WINE RECIPES and Catalog, 25¢. Country Winemaker, Box 191E, RFD 1, Mattapoisett, Massachusetts 02739.

POPULAR ELECTRONICS

SEPTEMBER 1971

ADVERTISERS INDEX

READER SERVICE NO.	ADVERTISER	PAGE NO.
	A.P.M. Systems	99
1	Acoustic Research, Inc.	14
2	Allied Radio Shack	12
3	Allied Radio Shack	95
5	Ampex	5
6	Ampex	16
7	Antenna Specialists Co., The	6
4	Avanti Research & Development Co., Inc. FOURTH COVER	
	Bell & Howell Schools	72, 73, 74, 75
	CREI, Home Study Div., McGraw-Hill Book Co.	90, 91, 92, 93
9	Career Academy	8
	Cleveland Institute of Electronics	14
11	Cleveland Institute of Electronics	36, 37, 38, 39
	Cleveland Institute of Electronics	107
13	Drake Company, R.L.	100
8	Cobra Div., DYNASCAN CORP.	9
14	EICD Electronic Instrument Co., Inc.	98
15	Edmund Scientific Co.	108
16	Heath Company	26, 27
17	Lafayette Radio Electronics	17
18	Mallory & Co., Inc., P.R.	23
19	McIntosh Labs	101
	National Radio Institute SECOND COVER, 1, 2, 3	
	National Technical Schools	18, 19, 20, 21
20	Olson Electronics	95
21	Precision Tuner Service	98
	RCA Electronic Components & Devices	28
	RCA Institutes, Inc.	54, 55, 56, 57
23	Regency Electronics	88
24	Sams, Howard W. & Co., Inc.	15
32	Shure Bros., Inc.	11
25	Sonar Radio Corp.	89
26	Southwest Technical Products	96
27	TDK Electronics Corp.	10
28	Techni-Tool, Inc.	96
29	Turner Microphone Co., The	25
30	University Sound	13
31	Utah Electronics	94

CLASSIFIED ADVERTISING 102, 103, 104, 105, 106

CALL ME!



I'll send you 2 FREE BOOKS describing the opportunities in Electronics. Call me TOLL-FREE **800-321-2155** (in Ohio, call 800-362-2105).

For details about the famous CIE home-study courses in Electronics, see our ad on page 36

Cleveland Institute of Electronics
1776 East 17th Street, Cleveland, Ohio 44114

POPULAR ELECTRONICS SUBSCRIBER SERVICE

Please include an address label when writing about your subscription to help us serve you promptly.

Write to: P.O. Box 1096, Flushing, N.Y. 11352

CHANGE OF ADDRESS: Please let us know you are moving at least six to eight weeks in advance. Affix magazine address label in space below and print new address in space provided. If you have a question about your subscription, attach address label to your letter.

If you have no label handy, print OLD address here.

name _____ please print
address _____
city _____
state _____ zip-code _____

TO SUBSCRIBE: Check these boxes: — New — Renewal
 5 years \$21 3 years \$15 1 year \$6

SPECIFY: Payment enclosed—You get 1 extra issue per year as a BONUS! Bill me later.

0552

name _____ please print
address _____
city _____ state _____ zip _____

Add'l postage: \$1 per year outside U.S., its possessions & Canada.

AFFIX LABEL

1000's OF UNUSUAL SCIENTIFIC BARGAINS including... SPECIAL UNIQUE PSYCHEDELIC LIGHTING for Fun, Profit, Effects!

NEW! ELECTRONIC DIGITAL COMPUTER KIT!



Solve problems, play games, predict weather with this actual working model of giant electronic brain. Amazing new fun way to learn all about computer programming... logic, decimal, binary systems, Laws of Sets—even do your own programming after completing simplified 116 page instructive booklet. Includes step-by-step assembly diagrams. Circuits easily changed. Readout from illuminated control panel. Req. 2 "D" batt. (not incl.). Best model we've seen—for home, school, industry.
Stock No. 71,434AV (11"X12 1/4"X4") \$31.50 Ppd.

CHROMATIC "MACHINE-GUN" STROBE



Red, Green & Blue light barrage the eyeballs every 6 seconds with this low-cost top-quality mechanical strobe that can run continuously without fear of burning up. Dazzling effects over 500 ft. sq. area. Created by rotating color wheel in front of 100W, 120V reflector floodlamp (inel. elements seem to flash windows, posters, parties into flashing, pulsating productions. Convection cooled. Rugged wrinkle finish metal case. Adjustable hanger bracket. Reg. house current.
Stock No. 71,423AV (9" X 9" X 6") \$32.75 Ppd.

PSYCHEDELIC LIGHTING HANDBOOK



100 information packed pages! Fully explains latest in psychedelic lighting equipment, techniques, developments. Covers all facets of psychedelic light-show production including strobes, black lights, projectors, crystals, organic slides, mirrors, color organs, polarized color, light boxes, MusicVision, etc. Shows how to "psychedelize" parties, musical groups, shows or how to set up electric trips for private gatherings. 8 1/2" x 11" looseleaf paper for 3 rings.
Stock No. 9100AV \$3.00 Ppd.

"FISH" WITH A MAGNET



Go treasure hunting on the bottom! Fascinating fun, sometimes profitable! Tie a line to our 5 1/2-lb. Magnet—drop it overboard in bay, river, lake or ocean. Trawl it along bottom—your "treasured" haul can be outboard motors, anchors, other metal valuables. 5 1/2-lb. Magnet is war surplus—Alnico V Type—Gov't. cost \$50. Lifts over 150 lbs. on line—much greater weights under water.
Stock No. 70,571AV 5 1/2 lbs. \$12.50 Ppd.
Stock No. 60,215AV 12 lbs. \$7.75 Ppd.
Stock No. 70,570AV 3 1/2 lbs. (40 lbs.) 8.75 Ppd.
Stock No. 85,152AV 15 1/4 lbs. (350 lbs.) \$33.50 FOB

BLACK-LIGHT MIGHTY MITES

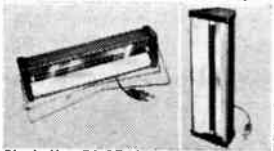

Relatively small (12") fixtures give surprisingly bright black-light. Mirror-finished reflector makes instant starting & wait, high-intensity bulb look like 40-watter. Up to 5,000 hours of safe, long-wave (3600A) black-light to really turn on parties, light & theatrical shows, psychedelic decors, holiday decorations. Shockproof end-caps remove for safe, easy replacement of bulb and starter. Stands upright or horizontal. Aluminum case.
Stock No. 71,274AV \$14.95 Ppd.
DELUXE OUTDOOR INDOOR MODEL
Stock No. 71,299AV \$19.95 Ppd.

Order by Stock No.—Check or M.O.—Money-Back Guarantee
EDMUND SCIENTIFIC CO., 300 EDCORP BLDG., BARRINGTON, N.J. 08007

WRITE FOR GIANT FREE CATALOG "AV"



Completely new edition. New items, categories, illustrations, 148 easy-to-read pages packed with 4000 unusual items. Dozens of electrical and electromagnetic parts, accessories. Enormous selection of Astronomical Telescopes, Microscopes, Binoculars, Magnifiers, Magnets, Lenses, Lasers, Prisms. Many war surplus items; for hobbyists, experimenters, workshops, factory. Write for catalog "AV."

GREAT INT'L PAPER PLANE BOOK!

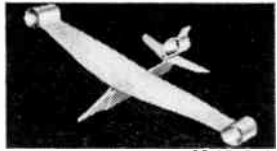

Official fly-them-yourself book of paper airplanes from SCF-774C. AMERICAN'S International Competition". Includes plans of all winning entries, time aloft records, photos, technical data, commentaries. Has 20 unusual designs on perforated pages for easy tear-out. You won't believe how some of them fly! Amusing, entertaining. 128 pages, 9"x11 1/2".
Stock No. 9391AV \$2.95 Ppd.

\$8.95 ELECTRONIC STROBE



Hand-sized solid state electronic light at fantastically low price. Produces bright psychodrive effects like larger, far more expensive Xenon strobes, yet it's just 2 1/4" X 4" X 1 3/8" thick. Adjustable flash rate, approximately 3-10 flashes per second. Make stop motion effects, posters come alive. Great to take with you to parties, dances, outings, etc. Requires 2 9v transistor batt. (not incl.). Instructions.
Stock No. 41,443AV \$8.95 Ppd.
4 REPLACEMENT LAMPS AV P-41,444 1.00 Ppd.

3-CHANNEL COLOR ORGAN BARGAIN!

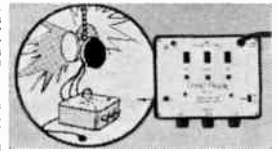

Create tremendous variety of unusual & beautiful lighting effects with this low-cost top-quality 1500-Watt unit (500 W. per channel). Compare with others selling for twice the price. Has pilot light, plus individual sensitivity controls and channel indicator lights. Can operate on 150 W. "spots" or 200 Christmas lights. Uses reg. house current—attaches to audio source w/RCA-type phone plug. 5 1/2" x 6 5/8" x 2 1/2" lbs. Thermal setting plastic case, 6 ft. cord. Including complete instructions.
Stock No. 71,223AV \$44.50 Ppd.

1st LOW-COST XENON STROBE!

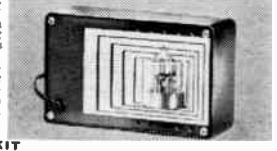

Price breakthrough in bright, reliable electronic strobes. 30W Second xenon tube. Variable flash rate—60 to 500 per minute. Long life—more than 1,000,000 flashes. Printed circuit board design. Safe, durable Bakelite case. Externally mounted bulb plastic shield. 6 1/4" X 3 3/4" X 2", 1.4 oz. Perfect for psychedelic, stop-action lighting effects for home light shows, parties, displays.
#71,342AV \$24.95 Ppd.
BUILD-IT-YOURSELF STROBE KIT
Stock No. 71,343AV \$19.95 Ppd.

HI-VOLTAGE ELECTROSTATIC GENERATOR



Van De Graaff low-amp type, 2,000,000 volt potential yet completely safe. Demonstrates lightning, St. Elmo's fire, repulsion charges, electrostatic dust collection, many other electrical wonders. Meter, 110v, 60-cycle, AC. Humidity range, 0-90%. Current, 1.5 to 2.5 microamps. Aluminum base, frame and charge collector. Unbreakable plastic, insulating column, 11" dia. 6 1/2". Full instructions.
Stock No. 70,264AV \$53.75 Ppd.
STATIC ELECTRICITY GENERATOR
Stock No. 70,070AV \$19.50 Ppd.

ASTRONOMICAL TELESCOPE KITS



Grind your own mirror for powerful telescopes. Kits contain fine annealed pyrex mirror blank, tool, abrasives, diagonal mirror, and eyepiece lenses. Instruments you build range in value from \$75 to hundreds of dollars.
Stock No. 70,003AV \$10.75 Ppd.
6" DIAMETER—1/2" Thick
Stock No. 70,004AV \$13.95 Ppd.
8" DIAMETER—1 3/8" Thick
Stock No. 70,005AV \$21.50 Ppd.
10" DIAMETER—1 3/4" Thick
Stock No. 70,006AV \$52.50 FOB

EDMUND SCIENTIFIC CO. ORDER BY STOCK NUMBER - OPEN ACCOUNT TO RATED FIRMS - MONEY-BACK GUARANTEE
300 EDCORP BLDG.
BARRINGTON, NEW JERSEY 08007

CIRCLE NO. 15 ON READER SERVICE CARD
Printed in U.S.A.

**Stock
up
now**

**with a
Popular Electronics
Subscription . .**

on:

- **Challenging Electronics Construction Projects.**
Practical, useful components for home, car, office, shop.
- **Valuable Test Equipment.**
Highly accurate, highly sensitive, low cost.
- **Vital Career Opportunity Information.** *What's available, how to qualify.*
- **Modern Electronic Music and Instrumentation.** *Music synthesis.*
- **Stereo and Hi-Fi Theory and Practice.** *Components, systems, multi-channel sound.*
- **New Developments in Electronics.** *Laser technology, desk calculators, satellite broadcasting.*
- **Radio and TV Communications.** *UHF, VHF, satellite, CATV, Ham, SWL, CB.*
- **Latest Literature, New Products.** *Free pamphlets and brochures, new books, products.*

Use handy card at right to order your subscription TODAY!

Popular Electronics

READER SERVICE

(free information)

Here's an easy and convenient way for you to get additional information about products advertised or mentioned editorially (if it has a reader service number) in this issue. Just follow the directions below . . . and the material will be sent to you promptly and free of charge.

1. On the attached postage-free card, print or type your name and address on the lines indicated.

2. Circle the number(s) that corresponds to the key number(s) at the bottom or next to the advertisement or editorial mention that is of interest to you. (Key numbers for advertised products also appear in the Advertisers' Index.)

3. Simply cut out the card and mail. No postage required.



SR12 STEREO TEST RECORD

Whether you're an avid audiophile, a casual listener or a professional technician . . . the new MODEL SR12 will be the most important disc in your entire collection.

MODEL SR12 has been produced by Stereo Review Magazine for music lovers who want immediate answers to questions about the performance of their stereo systems and how to get the best possible sound reproduction.

It is the most complete test record of its kind—containing the widest range of checks ever included on one test disc.

**Make these stereo checks BY EAR . . .
(no test instruments required)**

- Frequency response—a direct warble-tone check of nineteen sections of the frequency spectrum, from 20 to 20,840 Hz, which will pinpoint any frequency response defects in your system.
- Separation—an ingenious test which indicates whether you have adequate separation for good stereo.
- Cartridge tracking—the most sophisticated tests ever devised for checking the performance of your cartridge, stylus and tone arm.

- Channel balance—two broad-band, random-noise signals which permit you to eliminate any imbalances originating in cartridge, amplifier, speakers or room acoustics.
- Hum and rumble—foolproof tests that help you evaluate the actual audible levels of rumble and hum in your system.
- Flutter—a sensitive "musical" test to check whether your turntable's flutter is low, moderate, or high.

PLUS! ● Cartridge and Speaker Phasing ● Anti-Skating Adjustment ● "Gun Shot Test" for Stereo Spread ● Multi-purpose Musician's "A" ● Equal-tempered Chromatic Octave ● Guitar-tuning Tones.

Attention Professionals . . . Model SR12 is also designed to be used as a highly efficient design and measurement tool. Tests have been controlled to laboratory tolerances—affording accurate numerical evaluation when used with oscilloscope, chart recorder, output meter, intermodulation-distortion meter and flutter meter.

FREE Instruction Manual Includes Detailed Instruction, Charts, Tables, and Diagrams.

ONLY \$5.98 POSTPAID
**SEND NO MONEY TO RECEIVE YOUR
COPY OF STEREO REVIEW'S
SR12 STEREO TEST RECORD**

Here's all you have to do—circle #150 on the Information Service Card to the right. The record will be mailed to you along with an invoice for the regular price of only \$5.98, postpaid.

**SR12 STEREO TEST RECORD—
CIRCLE #150**

avanti

brings truth, power
and long distance
performance
in a new
CB ground
plane!



SIGMA 5/8 is a full size 22' tall $\frac{5}{8}$ wave ground plane designed to give strong, noise-free long distance performance. Look at these features: low angle radiation, fewer dead spots; efficient matching loop eliminates coils and transformers that can detune or burn out; adjustable radiator is pre-marked for easy "no-measuring" assembly; sturdy, heavy duty radials have stainless steel tips for reduced wind loading; all aircraft quality aluminum, stainless steel and fiberglass.

\$39⁹⁵

Look at the specs:

Gain—5.14 db over isotropic, 4.17 db over $\frac{1}{4}$ wave ground plane, 3.0 db over $\frac{1}{2}$ wave dipole;
VSWR—1.3:1 or less;
Height—22';
Weight—9 lbs.;
Telescopes for 10-meter ham use and can handle 1000 watts power.



avanti

33 - 35 WEST FULLERTON AVENUE,
ADDISON, ILLINOIS 60101

SIGMA 5/8
DESIGNED SPECIFICALLY
FOR AM & SSB